



i450T
Dive Computer Owner's Manual

NOTICES

LIMITED TWO-YEAR WARRANTY

For warranty details and to register your product, refer to www.aqualung.com.

COPYRIGHT NOTICE

This owner's manual is copyrighted, all rights are reserved. It may not, in whole or in part, be copied, photocopied, reproduced, translated, or transferred to any other form without prior consent in writing from Aqua Lung.

i450T Dive Computer Owner's Manual, Doc. No. 12-7834
© Aqua Lung International, Inc., 2015
Vista, CA USA 92081

TRADEMARK, TRADE NAME, AND SERVICE MARK NOTICE

Aqua Lung, the Aqua Lung logo, i450T, the i450T logo, Gas Time Remaining (GTR), Diver Replaceable Batteries, Graphic Diver Interface, Pre-Dive Planning Sequence (PDPS), SmartGlo, Set Point, Control Console, Turn Gas Alarm, and Aqua Lung computer Interface (ALI) are all registered and unregistered trade-marks, trade names, and service marks of Aqua Lung. All rights are reserved.

PATENT NOTICE

U.S. Patents have been issued to protect the following design features: Dive Computer with Free Dive Mode and/or Wireless Data Transmission (U.S. Patent no. 7,797,124), GTR/Air Time Remaining (U.S. Patent no. 4,586,136 and 6,543,444) and Data Sensing and Processing Device (U.S. Patent no. 4,882,678). Set N2 Bar Graph Alarm (NIBG Alarm) and other patents pending. User Settable Display (U.S. Patent no. 5,845,235) is owned by Suunto Oy (Finland).

DECOMPRESSION MODEL

The program within the i450T simulates the absorption of inert gases into the body by using a mathematical model. This model is merely a way to apply a limited set of data to a large range of experiences. The i450T dive computer model is based upon the latest research and experiments in decompression theory. Still, using the i450T, just as using any other No Decompression Tables, is no guarantee of avoiding decompression sickness, i.e. "the bends". Every diver's physiology is different, and can even vary from day to day. No machine can predict how your body will react to a particular dive profile.

DANGERS, WARNINGS, CAUTIONS, AND NOTES

Pay attention to the following symbols when they appear throughout this document. They denote important information and tips.

 **DANGERS:** are indicators of important information that if ignored **would** lead to severe injury or death.

 **WARNINGS:** are indicators of important information that if ignored **could** lead to severe injury or death.

 **CAUTIONS:** indicate information that will help you avoid faulty assembly, leading to an unsafe condition.

 **NOTES:** indicate tips and advice that can inform of features, aid assembly, or prevent damage to the product.

RESPONSIBLE COMPUTER DIVING

- Always plan each dive.
- Always limit your dive to the level of your training and experience.
- Always make your deepest dive first.
- Always make the deepest part of every dive first.
- Check your computer often during the dive.
- Do a safety stop on every dive.
- Allow adequate surface interval between each dive.
- Allow adequate surface interval between each day of diving (12 Hours or until your computer clears).
- Read and understand this manual thoroughly before using the i450T.



WARNINGS:

- The i450T is intended for use by recreational divers who have successfully completed a nationally recognized course in scuba diving, and diving with enriched nitrogen-oxygen (nitrox) breathing gas mixtures.
- It is intended only for no decompression diving, NOT intentional decompression diving.
- It must not be used by untrained persons who may not have knowledge of the potential risks and hazards of scuba diving, and diving with enriched nitrogen-oxygen (nitrox) mixtures.
- You must obtain scuba certification, and certification in diving with enriched nitrogen-oxygen mixtures (nitrox) before using the i450T for nitrox diving.
- It is NOT for use by military and commercial divers.
- It should NOT be utilized for any competitive, or repetitive square wave or decompression diving, as it is intended solely for recreational use and no decompression multilevel diving.
- As with all underwater life support equipment, improper use or misuse of this product can cause serious injury or death.
- Never participate in sharing or swapping of a dive computer.
- Conduct your dives in such a manner so as to insure that you continuously check the computer's proper function.
- Read and understand this owner's manual completely before diving with the i450T.
- If you do not fully understand how to use this dive computer, or if you have any questions, you should seek instruction in its use from your authorized Aqua Lung dealer before you utilize this product.
- If your i450T stops working for any reason while operating, it is important that you have anticipated this possibility and are prepared for it. This is an important reason for not pushing the tables, oxygen exposure limits, and a critical reason to avoid entering decompression, without proper training. If you dive in situations where your trip would be ruined or your safety would be jeopardized by losing the use of your i450T, a backup instrument system is highly recommended.
- Each numeric and graphic display represents a unique piece of information. It is imperative that you understand the formats, ranges, and values of the information represented to avoid any possible misunderstanding that could result in error.
- Remember that technology is no substitute for common sense, and a dive computer only provides the person using it with data, not the knowledge to use it. Remember also that the dive computer does not actually measure and test the composition of your body tissue and blood. Using an Aqua Lung dive computer, just as using the U.S. Navy (or other) Decompression Tables, is no guarantee of avoiding decompression sickness. Every diver's physiology is different, and can even vary from day to day. No machine can predict how your body will react to a particular dive profile.
- Diving at high altitude requires special knowledge of the variations imposed upon divers, their activities, and their equipment by the decrease in atmospheric pressures. Aqua Lung recommends completion of a specialized altitude training course by a recognized training agency prior to diving in high altitude lakes or rivers.
- Repetitive dives in a series should only be conducted at the same altitude as that of the first dive of that series. Repetitive dives made at a different altitude will result in an error equal to the difference in barometric pressure, and possibly a false dive mode with erroneous data.
- If the i450T is activated at an elevation higher than 14,000 feet (4,270 meters), it will immediately shutdown.
- Decompression diving, or diving deeper than 130 ft (39 m), will greatly increase your risk of decompression sickness.
- Using an i450T is no guarantee of avoiding decompression sickness.
- The i450T enters Violation Mode when a situation exceeds its capacity to predict an ascent procedure. These dives represent gross excursions into decompression that are beyond the boundaries and spirit of the i450T's design. If you are following these dive profiles, Aqua Lung advises that you should not use an i450T.
- If you exceed certain limits, the i450T will not be able to help you get safely back to the surface. These situations exceed tested limits and can result in loss of some functions for 24 hours after the dive in which a violation occurred.

CONTENTS

NOTICES	2	SET AL (ALARMS)	31
RESPONSIBLE COMPUTER DIVING	2	1. AUD AL (Audible Alarms)	31
WARNINGS:	3	2. DEPTH AL (Audible Alarms)	31
GETTING STARTED	6	3. EDT AL (Elapsed Dive Time Alarm)	32
BASICS	7	4. N2 AL (Nitrogen Alarm)	32
INITIAL ACTIVATION	7	5. DTR AL (Dive Time Remaining Alarm)	33
DISPLAY ICONS	8	6. TURN AL (Turn Pressure Alarm)	33
BUTTONS	9	7. Press AL (Pressure Alarm)	34
BUTTON FUNCTIONS	10	SET UTIL (UTILITIES)	34
WATCH MODE	12	1. H2O TYPE (Water Type)	34
WATCH MAIN SCREEN	13	2. H2O ACTIV (Water Activation)	35
ALT 1	13	3. UNITS (IMP/MET)	35
ALT 2	14	4. DEEP STOP	35
WATCH MAIN MENU	14	5. SAFE STOP (SAFETY STOP)	36
CDT (Countdown Timer) SETUP	15	6. CONSERV (Conservative Factor)	36
CHRONO (CHRONOGRAPH)	15	7. LIGHT DURA (DURATION)	36
DAILY AL (ALARM)	16	8. SAMPLING (SAMPLE RATE)	37
TIME MENU	16	9. TMT MENU (TRANSMITTER MENU)	37
1. Date Form (Format)	16	OP MODE (OPERATION MODE)	38
2. Date Form (Format)	17	HISTORY	39
3. Time Of Day	17	ID-SN (SERIAL NUMBER)	39
4. Date	17	BATT/TMT (BATTERY/TRANSMITTER STATUS)	39
5. Alt Time	18	DIVE OPERATION	40
6. DFLT (Default) Time	18	INITIATING A DIVE	41
7. Show Dual	18	NO DECOMPRESSION DIVE MAIN	41
DIVE FEATURES	19	DIVE ALT 1	42
DTR (DIVE TIME REMAINING)	20	DIVE ALT 2	42
NO DECOMPRESSION	20	DEEP STOP PREVIEW	42
O2 MIN (OXYGEN TIME REMAINING)	20	EARMARK	42
BAR GRAPHS	20	DEEP STOP MAIN	43
ASC BAR GRAPH	21	SAFETY STOP MAIN	43
N2 BAR GRAPH	21	SURFACING	43
ALGORITHM	21	GAS/TRANSMITTER SWITCHES	44
CONSERVATIVE FACTOR	21	OVERVIEW	44
DS (DEEP STOP)	21	COMPLICATIONS	46
SS (SAFETY STOP)	22	DECOMPRESSION	46
LOW BATTERY WHILE ON THE SURFACE	22	DECOMPRESSION ENTRY	46
LOW BATTERY DURING A DIVE	22	DECOMPRESSION STOP MAIN	46
AUDIBLE ALARM	23	CONDITIONAL VIOLATION (CV)	47
PROXIMITY OF THE TRANSMITTERS AND i450T	24	DELAYED VIOLATION 1 (DV 1)	47
DIVE SURFACE MODE	25	DELAYED VIOLATION 2 (DV 2)	48
ON THE SURFACE BEFORE A DIVE	26	DELAYED VIOLATION 3 (DV 3)	48
ALT 1 (LAST DIVE)	26	VIOLATION GAUGE MODE DURING A DIVE	48
ALT 2	26	VIOLATION GAUGE MODE ON THE SURFACE	49
ALT 3	27	HIGH PO ₂	49
DIVE SURF MAIN MENU	27	Warning	49
FLY/DESAT	28	Alarm	49
PLAN	28	HIGH O2 SAT (OXYGEN SATURATION)	50
LOG	29	PO ₂ During Decompression	50
SET GAS	30	Warning	50
		Alarm	50
		Warning During Decompression	50
		Alarm During Deco	51
		Alarm On Surface	51

GAUGE MODE	52	SERVICE	75
ON THE SURFACE BEFORE A DIVE	53	BATTERY REPLACEMENT	76
GAUGE SURF MAIN MENU	53	ALTITUDE SENSING AND ADJUSTMENT	78
RUN TIMER	54		
INITIATING A DIVE	54	TECHNICAL DATA	79
GAUGE DIVE MAIN	55	NO DECO TIME LIMITS	80
GAUGE DIVE ALT	55	OXYGEN EXPOSURE LIMITS	81
DELAYED VIOLATION 3 (DV3)	55	ALTITUDE LEVELS	81
		SPECIFICATIONS	82
		ABBREVIATIONS/TERMS	85
FREE MODE	56		
FREE DIVE MODE DETAILS	57		
ON THE SURFACE BEFORE A DIVE	58		
FREE SURF MAIN MENU	58		
TIMER	59		
COUNTDOWN TIMER (CDT) SETUP	59		
LOG/HIST (HISTORY)	59		
Day Log	60		
Full Log	60		
Day Hist (History)	60		
Full Hist (History)	61		
SET ALARMS	61		
1. AUD (Audible) Alarm	61		
2. SRT (Surface Recovery Time) Alarm	62		
3. RTI (Repeating Time Interval) Alarm	62		
4. RDI (Repeating Depth Interval) Alarm	63		
5. DA 1-3 AL (Depth Alarm 1-3)	63		
SET UTIL (UTILITY)	64		
OP (OPERATION) MODE	64		
1. DSD (Dive Start Depth)	64		
2. DSI (Dive Surface Interval)	64		
ID-SN	64		
INITIATING A DIVE	65		
FREE DIVE MAIN	65		
FREE DIVE ALT	65		
HIGH NITROGEN ALARMS	66		
COMPASS MODE	67		
COMPASS DISPLAY ICONS	68		
OVERVIEW	69		
COMPASS MAIN MENU	69		
STAND MODE (STANDARD MODE)	69		
REF MODE (REFERENCE MODE)	70		
Set Reference Menu	70		
CALIBRATE	71		
SET DECLIN (DECLINATION)	71		
TIMEOUT	72		
EARMARK	72		
ALARMS	72		
ASC (Ascent) Alarm	72		
Depth Alarm	72		
REFERENCE	73		
PC INTERFACE	74		
CARE AND CLEANING	75		

GETTING STARTED

BASICS

Welcome to your new i450T. The i450T is an easy to use dive computer utilizing a four button interface. Divers may choose between four modes of functionality consisting of Watch, Dive, Gauge, and Free Mode. Though the i450T is easy to use, you will get the most out of your new i450T if you take some time to familiarize yourself with its displays and operation. Information has been organized into easy to follow sections to aid you in learning all you need to know. There is also a glossary at the end of this guide for any terms that may sound unfamiliar.

INITIAL ACTIVATION

i450T Watch/Dive Computers are placed in a Deep Sleep mode prior to being shipped from the factory. The intent is to extend storage life of the Battery for up to 7 years, before the unit is initially placed into service.

In this mode, Date and Time are updated as they normally would be. However, they are not displayed. Upon waking the i450T up, the correct Date and USA Pacific Time will be displayed and it will be ready to operate with full functions.

To wake the i450T up from Deep Sleep mode, simultaneously depress the upper/right (SELECT) and lower/left (ADV) buttons for 3 seconds until the display comes ON displaying the Watch Main Time screen, then release them.

NOTE: Once the i450T is brought out of the Deep Sleep mode, it can only be placed back into it by the factory.

DISPLAY ICONS

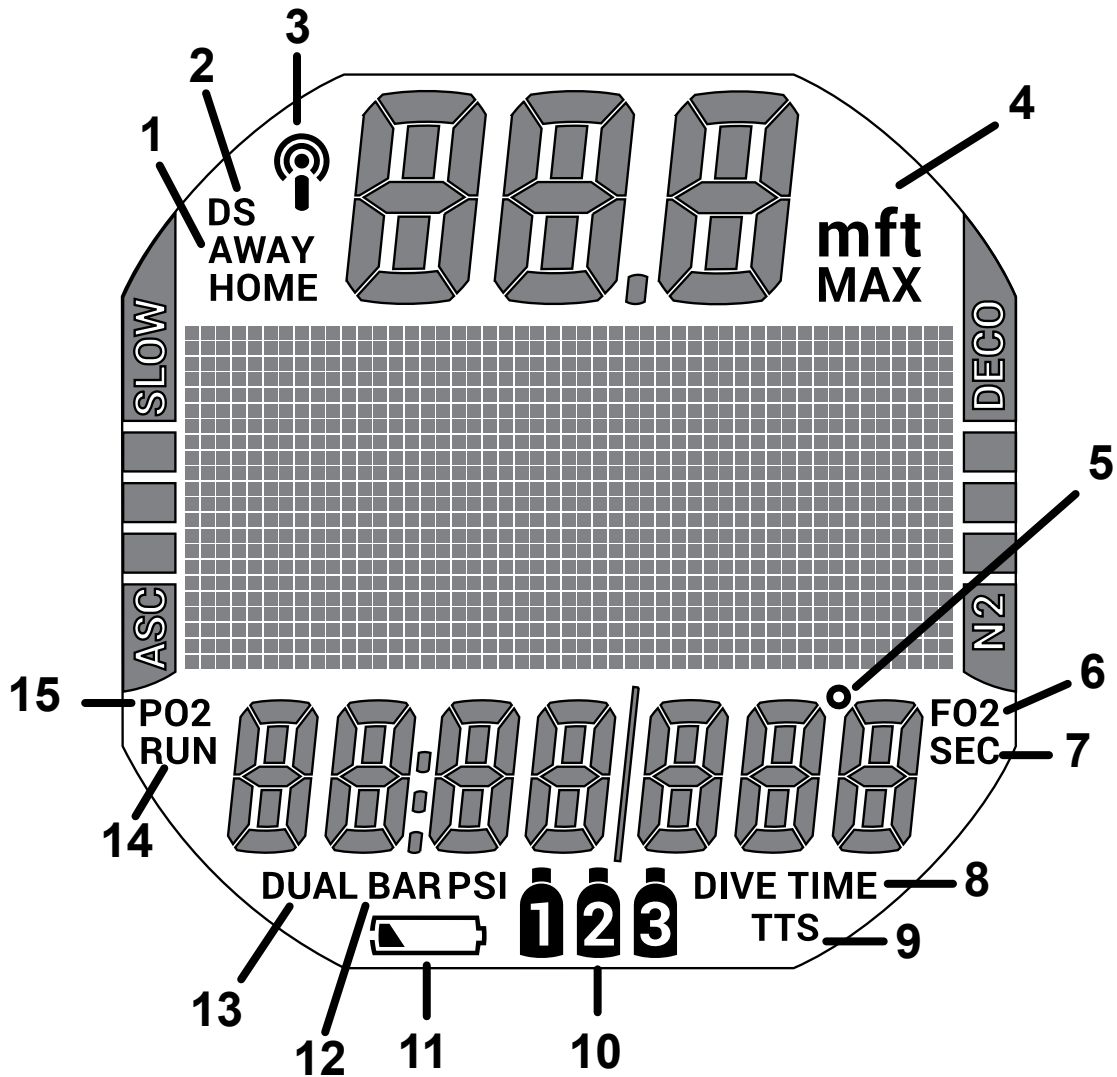

1	Time ID
2	Deep Stop
3	Daily Alarm or TMT Link
4	Depth ID (units)
5	Degrees (temp. or heading)
6	Fraction of Oxygen
7	Value is Seconds
8	Dive Time or Dive #

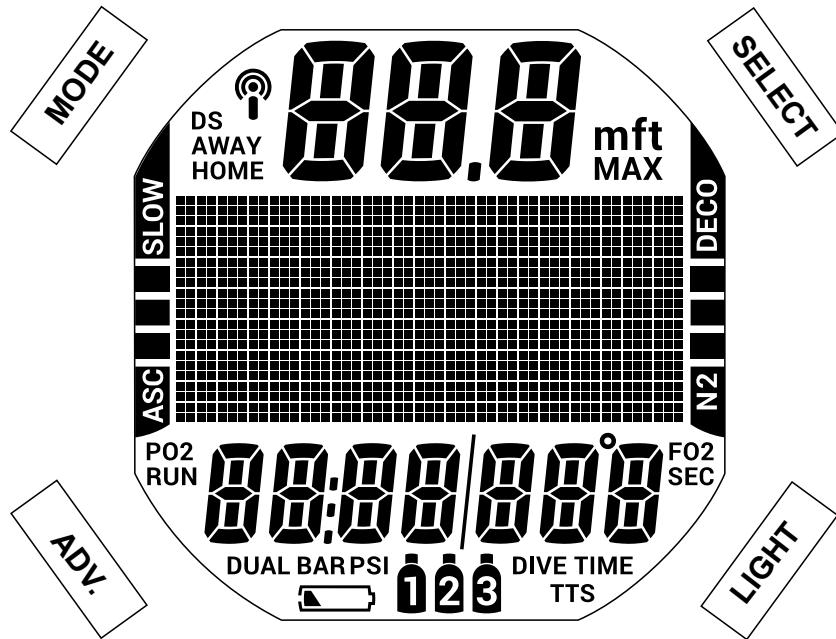

9	Value is Time To Surface
10	Gas/TMT #
11	Low Battery
12	Value is Pressure
13	Alternate Time Zone
14	Run Timer
15	Partial Pressure of Oxygen













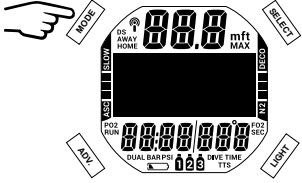

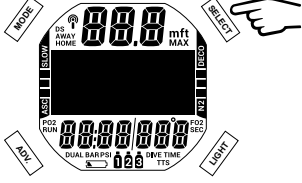
BUTTONS

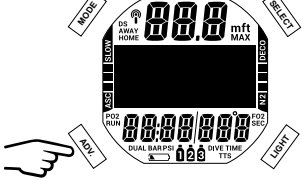

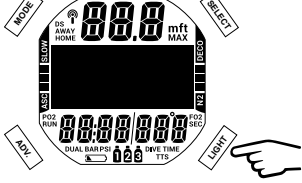

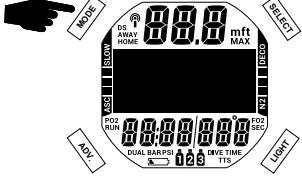
The i450T utilizes 4 control buttons called the MODE, SELECT, ADV. (Advance) and, LIGHT buttons. They allow you to select mode options and access specific information. They are also used to enter settings, activate the backlight, and acknowledge the audible alarm.

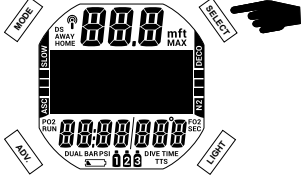
Pressing different combinations of these buttons will navigate through different menus and options of the i450T. The symbols in the table below will illustrate how to proceed through the menus.

SYMBOL	MEANING
	<p>PRESS BUTTON LESS THAN 2 SECONDS</p>
	<p>HOLD BUTTON GREATER THAN 2 SECONDS</p>

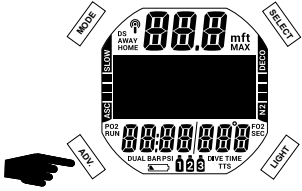
BUTTON FUNCTIONS

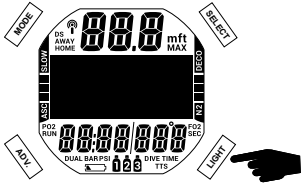
ACTION	BUTTON	FUNCTION
		<ul style="list-style-type: none"> • to access main menus from main screens • to step up the screen, backward through selections • to toggle or change setpoints • to apply Earmark
		<ul style="list-style-type: none"> • to select, save an option or setting
		<ul style="list-style-type: none"> • to access Alt screens • to step down the screen, advance through selections • to toggle or change setpoints
		<ul style="list-style-type: none"> • to manually turn the backlight on or off
		<ul style="list-style-type: none"> • to switch between Watch Mode and the active diving mode, while on the Main screen • to exit a menu directly to the Main screen
		<ul style="list-style-type: none"> • to switch between Compass Mode and the active diving mode, while on the Main screen • to exit or step back to the previous screen or setting

ACTION	BUTTON	FUNCTION
		<ul style="list-style-type: none"> • to increase a setting value at a faster rate
		<ul style="list-style-type: none"> • to reset backlight timer

WATCH MODE

WATCH MAIN SCREEN

The Watch Main screen is the default screen of the i450T. The i450T allows you to choose between displaying one or two time zones. This is useful when wearing the i450T as your primary timepiece while travelling.

NOTE: The terms HOME and AWAY are intended to represent two different time zones, your local and destination time zones respectively. Either time can be set as the Default Time. If DUAL time is set ON, the time zone that is not set as the Default Time will display in the lower left of the screen.

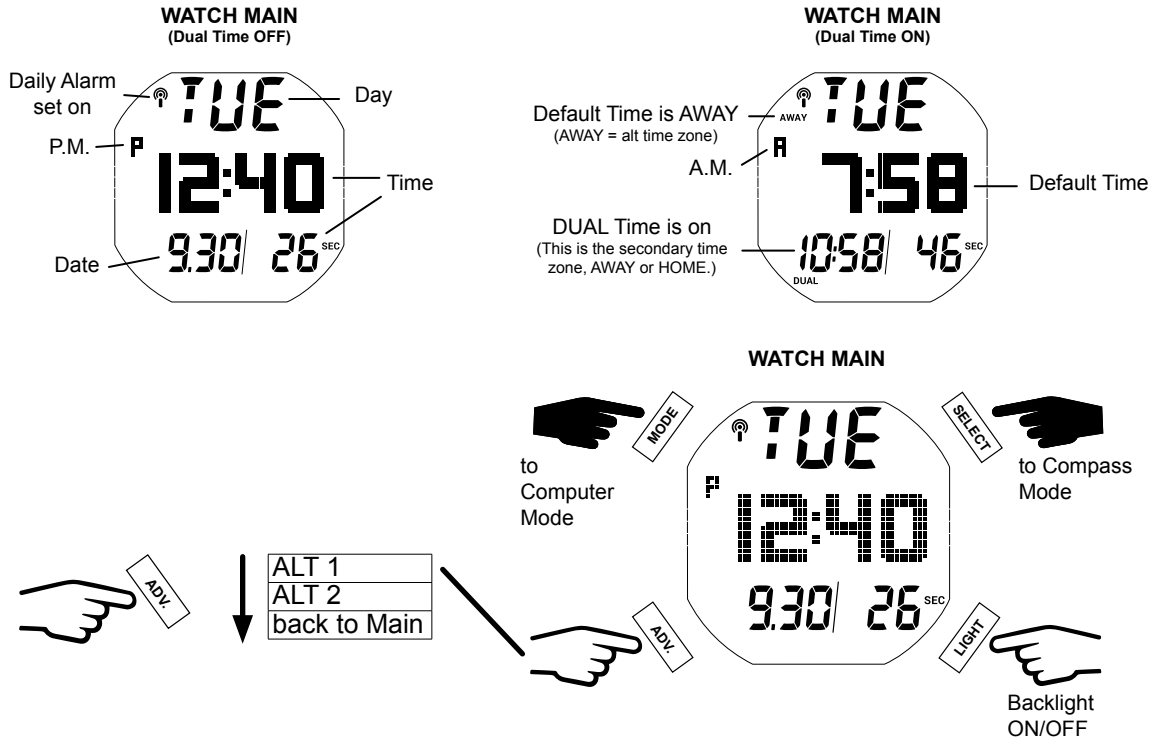

ALT 1

ALT 1 displays the time zone, AWAY or HOME, that is not displayed on Watch Main.

NOTE: ALT 1 is bypassed if Alt Time is set OFF or Show Dual is Set to ON.

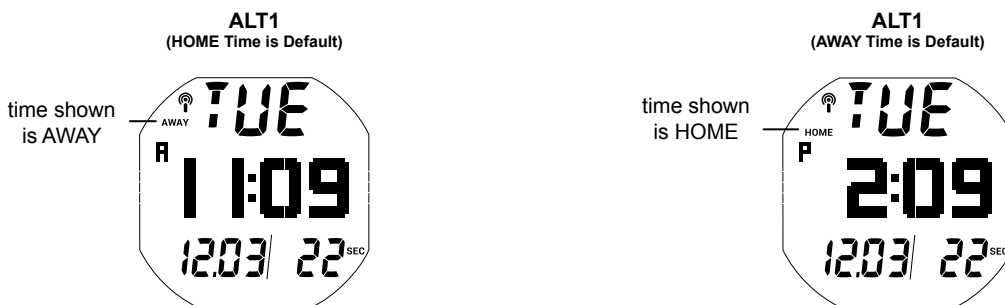

ALT 2

ALT 2 displays elevation, temperature, date (if not showing on Main), and allows access to the CDT (Countdown Timer).

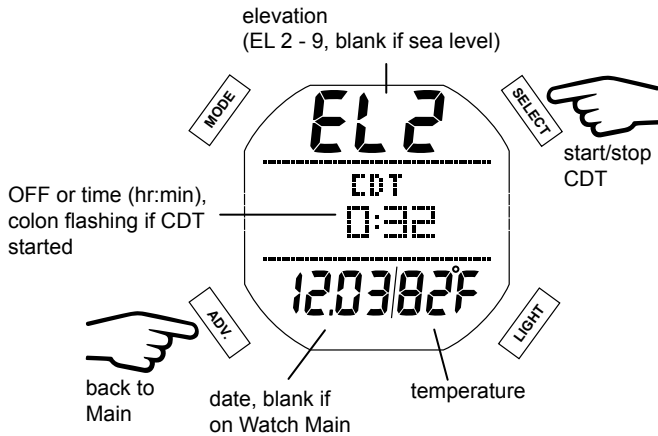

WATCH MAIN MENU

Enter the menu by pressing the MODE button. Press the SEL button to choose submenus or options from the Main Menu when available. All Main Menu screens and options will be discussed in the order they appear in the menu below.

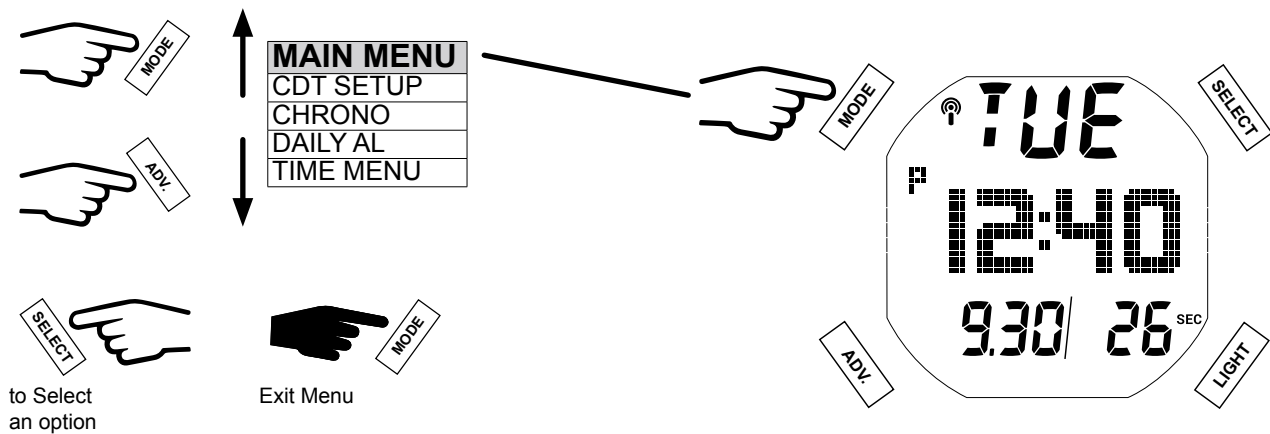

CDT (Countdown Timer) SETUP

This screen allows you to program a countdown timer with audible alarm. Choose ON, OFF, or SET. To set the timer you must save an hour value then the minute value. You may choose a value between 0:01 and 23:59. Once the CDT is set to ON, it may be started and paused in the ALT 2 screen. Selecting ON does not start the CDT; it must be activated in the Watch ALT 2 screen. See Alt 2 section in this chapter for further details.

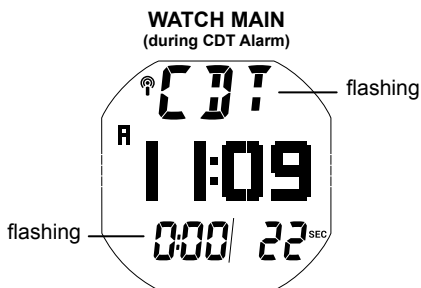
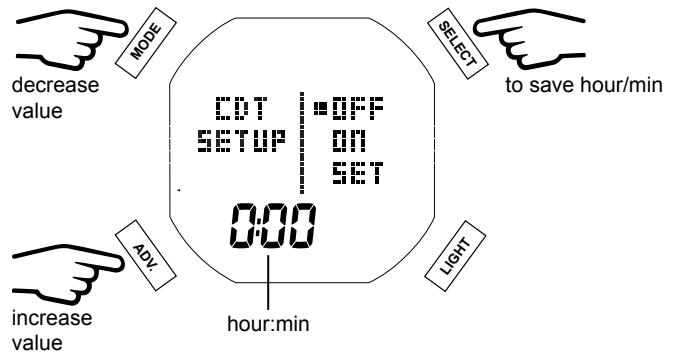
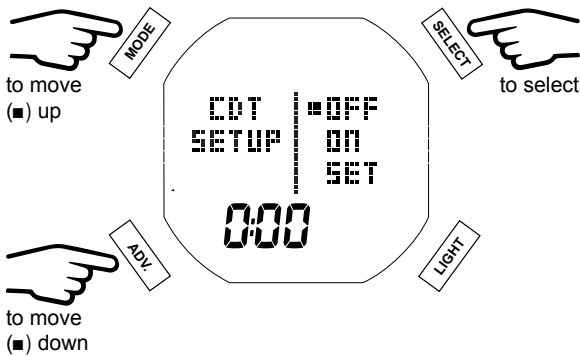

CHRONO (CHRONOGRAPH)

The chronograph has a 9 lap memory. After 9, subsequent laps will be recorded and the earliest lap discarded. If the Chrono continues to run and reaches 9:59:59.99, it will stop and record that as a Lap. Subsequent presses of SELECT then have no effect.

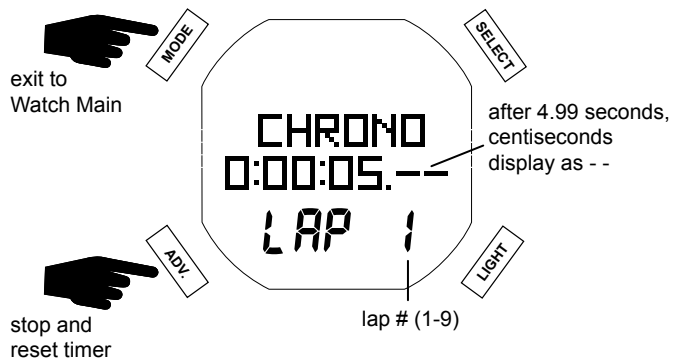
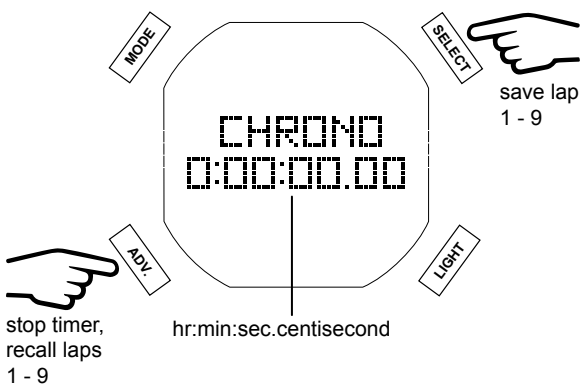

NOTE: If the Chrono continues to run and reaches 9:59:59.99, it will stop and record that as a Lap. Subsequent presses of SELECT then have no effect.

NOTE: Once the Chrono has been set and started, it will remain on and displayed (or continue to run in the background) while on the surface until reset by the user. Upon descending to 5 FT/1.5 M (i.e., entry into a Dive, Gauge, or Free Mode dive), operation will be terminated and the counter will reset to 0:00:00.00 (hr:min:sec.centisecond).

DAILY AL (ALARM)

When set ON, the Daily Alarm, that runs in the background, will sound the audible alarm at the time set every day when that time equals the Watch Default Time selected. The Audible will not sound while operating in dive computer modes. Operation reverts back to Watch Main after selection ON or OFF options.

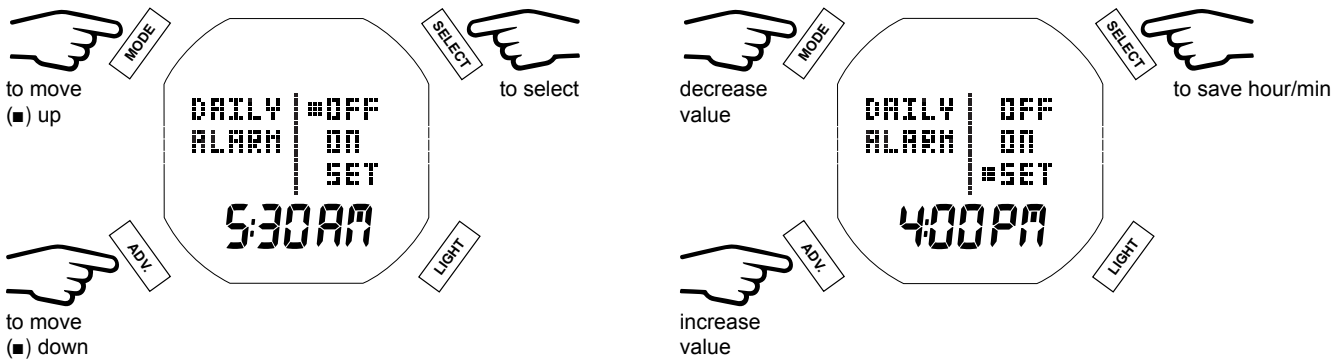

TIME MENU

Selecting Time Menu accesses a sub menu. Within this menu you can set the time settings: Date Form, Hour Form, Time, Date, Alt Time, DFLT Time, and Show Dual.

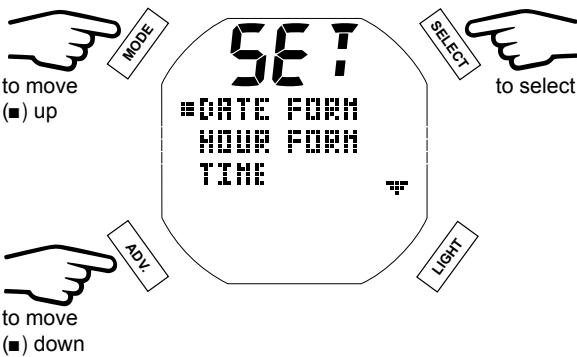

1. Date Form (Format)

Choose your preferred date format.

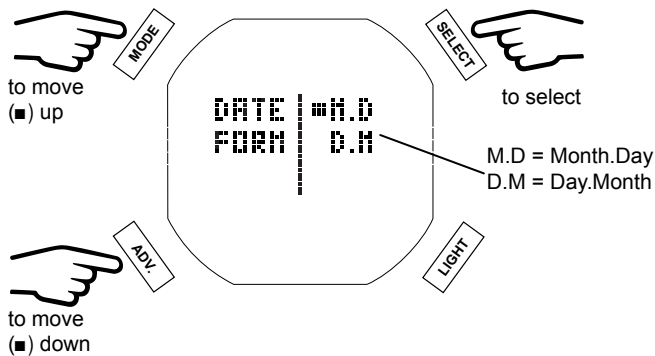

2. Date Form (Format)

Choose your preferred hour format.

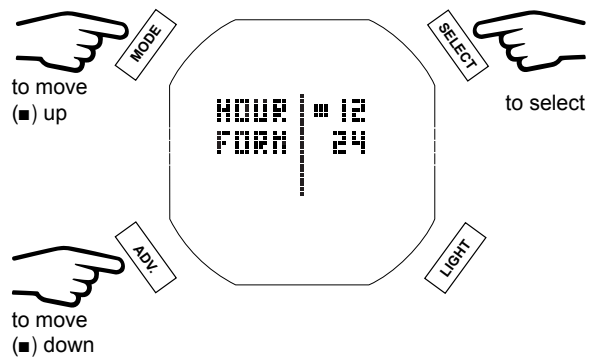

3. Time Of Day

Set the Default Time. Set hours then minutes.

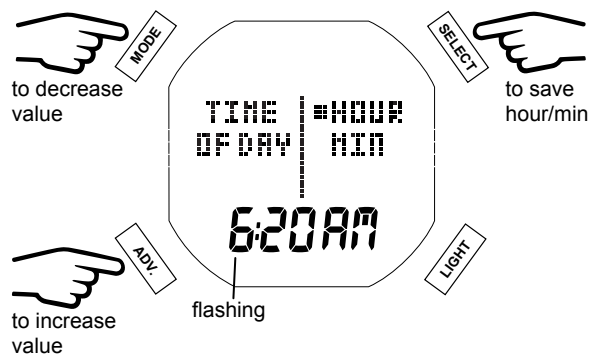

4. Date

Set the year, mnth (month), and day in order. The corresponding digit will flash, allowing it to be set.

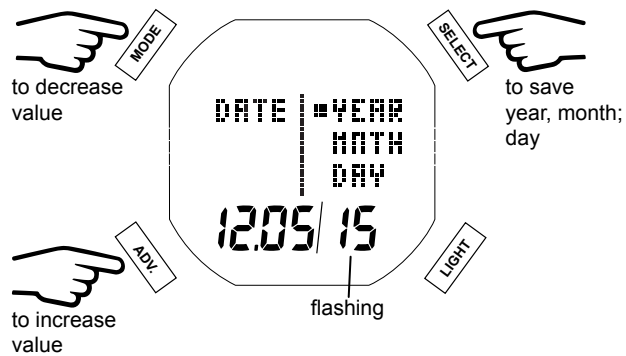

5. Alt Time

Alt Time allows you to set another time zone that is referred as AWAY Time. Selections available are OFF or (-23 - +23) hour difference.

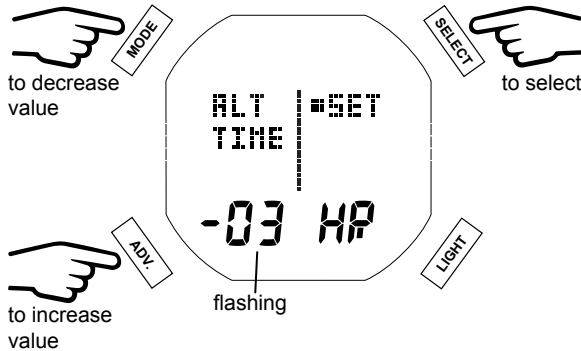

6. DFLT (Default) Time

This setting allows you to choose the time HOME or AWAY that displays as the default on the Watch Main.

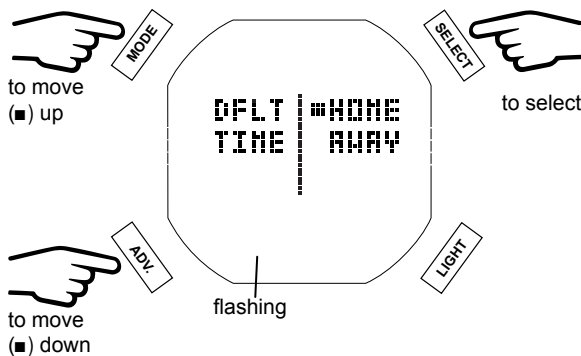

7. Show Dual

This setting allows you to choose whether or not to show dual time zones, both HOME and AWAY, on the Watch Main screen. If you select yes, the date will be replaced with the second time reading. The date can then still be viewed on the Alt 2 screen.

NOTE: If the Alt Time was set previously to OFF (00 hour difference), NO will be the only available option on the Show Dual screen.

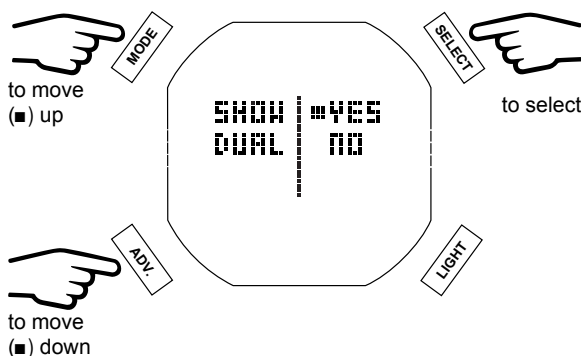



DIVE FEATURES



DTR (DIVE TIME REMAINING)

The i450T constantly monitors No Decompression status and O2 Accumulation, and will display whichever Time is the least amount available as DTR on the No Decompression Dive Main screen. The Time being displayed will be identified by the NO DEC (no decompression) or O2 MIN icons.

NO DECOMPRESSION

No Decompression is the maximum amount of time that you can stay at your present depth before entering decompression. It is calculated based on the amount of nitrogen absorbed by hypothetical tissue compartments. The rates each of these compartments absorb and release nitrogen is mathematically modeled and compared against a maximum allowable nitrogen level.

Whichever compartment is closest to this maximum level is the controlling compartment for that depth. Its resulting value NO DEC (no decompression) will be displayed. It will also be displayed graphically as the N2 Bar Graph, see Bar Graphs below.

As you ascend, the N2 Bar Graph segments will recede as control shifts to slower compartments. This is a feature of the decompression model that is the basis for multilevel diving, one of the most important advantages that Aqua Lung dive computers offer.

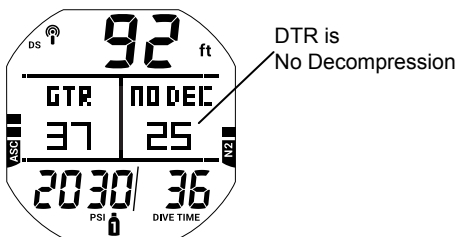

O2 MIN (OXYGEN TIME REMAINING)

When set for nitrox operation, O2 SAT (Oxygen Saturation) during a dive is displayed on an ALT screen as a percentage of allowed saturation identified by the O2 SAT icon. The limit for O2 SAT (100%) is set at 300 OTU (Oxygen Tolerance Units) per dive or 24 hour period. See the chart at the back of this manual for specific times and allowances. O2 SAT and O2 MIN values are inversely related; as the O2 SAT value increases the O2 MIN value decreases.

When the O2 MIN value becomes less than the No Decompression calculations for the dive, DTR (Dive Time Remaining) will be controlled by O2 SAT and the O2 MIN value will be displayed as the DTR on the Dive Main screen, identified by the O2 MIN icon.

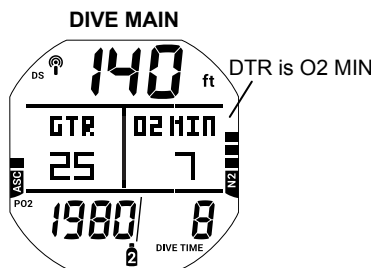
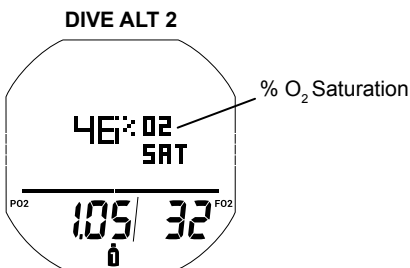

BAR GRAPHS

The i450T features two specific bar graphs.

1. The one on the left represents ascent rate. It is referred to as ASC Bar Graph.
2. The one on the right represents nitrogen loading. It is referred to as the N2 Bar Graph.

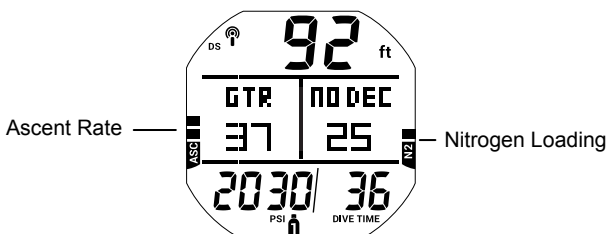

ASC BAR GRAPH

The ASC Bar Graph provides a visual representation of ascent speed (i.e., an ascent speedometer). When the ascent is faster than the recommended 30 fpm (9 mpm), all segments flash until the ascent is slowed.

# OF SEGMENTS	ASCENT RATE, FPM (MPM)
0	0 - 10 (0 - 3)
1	11 - 15 (3.1 - 4.5)
2	16 - 20 (4.6 - 6)
3	21 - 25 (6.1 - 7.5)
4	26 - 30 (7.6 - 9)
5	> 30 (> 9)

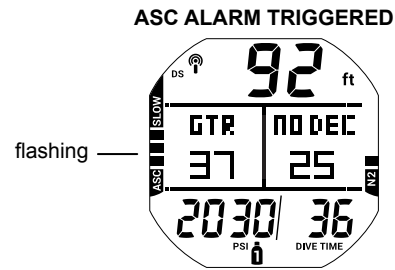

N2 BAR GRAPH

The N2 Bar Graph represents your relative No Decompression or Decompression status. The first four segments represent No Decompression status and the fifth indicates a Decompression condition. As your Depth and Elapsed Dive Time increase segments are added. As you ascend segments recede, indicating that additional No Decompression time is available. The i450T monitors twelve different nitrogen compartments simultaneously and the N2 Bar Graph displays the one that is in control of your dive at any given time.

ALGORITHM

The i450T utilizes the PZ+ algorithm to calculate nitrogen tissue loading. Performance is based on Bühlmann ZHL-16C algorithm model. To create even greater margins of safety with respect to decompression, a Conservative Factor as well as No Decompression Deep and Safety Stops can be included for No Decompression dives.

CONSERVATIVE FACTOR

When the CF is set On, the dive time remaining, No Decompression/O2 MIN, which are based on the algorithm and used for N2/O2 calculations and displays relating to Plan Mode, will be reduced to the values available at the altitude level that is 3,000 ft (915 m) higher than the actual altitude at activation. Refer to the charts in the back of this manual for dive times.

DS (DEEP STOP)

When the DS selection is set ON, it will trigger after descending deeper than 80 ft (24 m). The i450T then calculates (continually updating) a Stop Depth equal to ½ the Max Depth.

NOTE: The DS feature only works in DIVE Mode while within No Decompression times.

- While 10 ft (3 m) deeper than the calculated DS, you will be able to access a DS Preview screen that will display the current calculated Deep Stop Depth/Time.
- Upon initial ascent to within 10 ft (3 m) below the calculated Stop Depth, a DS screen displaying a Stop Depth at ½ the Max Depth will appear with a countdown timer beginning at 2 min and counting down to 0. If you descend 10 ft (3 m) below, or ascend 10 ft (3 m) above, the calculated Stop Depth for 10 seconds during the countdown, the No Decompression Main will replace the DS Main display and the DS feature will be disabled for the remainder of that dive. There is no Penalty if the DS is ignored.
- In the event that you enter Decompression, exceed 190 ft (57 m), or a High O2 SAT (Oxygen Saturation) condition, ≥ 80%, occurs, the DS will be disabled for the remainder of that dive.
- The DS is disabled during a High PO₂ Alarm condition, ≥ set point.

SS (SAFETY STOP)

Upon ascent to within 5 ft (1.5 m) deeper than the SS depth set for 1 second on a No Decompression dive in which Depth exceeded 30 ft (9 m) for 1 second, a beep will sound and a SS at the depth set will appear on the Dive Main display with a countdown beginning at the SS time set and counting down to 0 min.

- If the SS was set for OFF, the display will not appear.
- In the event that you descend 10 ft (3 m) deeper than the Stop Depth for 10 seconds during the countdown, or the countdown reaches 0, the No Decompression Main screen will replace the SS Main screen which will reappear upon ascent to within 5 ft (1.5 m) deeper than the Safety Stop depth set for 1 second.
- In the event that you enter Decompression during the dive, complete the Decompression obligation, then descend below 30 ft (9 m); the SS Main will appear again upon ascent to within 5 ft (1.5 m) deeper than the SS depth set for 1 second.
- If you ascend 2 ft (0.6 m) shallower than the SS depth for 10 seconds prior to completing it, the SS will be canceled for the remainder of that dive.
- There is no penalty if you surface prior to completing the SS or choose to ignore it.

LOW BATTERY WHILE ON THE SURFACE

Warning Level

- The i450T functions continue but the backlight is disabled.
- The Battery icon appears solid.

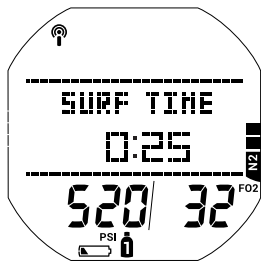

Alarm Level

- All operations cease.
- The Battery icon flashes for 5 seconds then the unit shuts off.

⚠ WARNING: Change the battery before diving if your i450T indicates the Battery Low Warning or Alarm.

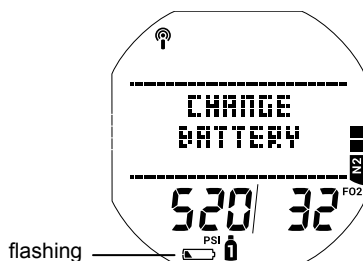

LOW BATTERY DURING A DIVE

Warning Level

- The i450T functions continue but the backlight is disabled.
- The battery icon appears solid upon entry into Surface Mode.

Alarm Level

- The i450T functions continue but the backlight is disabled.
- The Battery icon appears flashing. 5 seconds after entering Surface Mode the i450T will shut down.

AUDIBLE ALARM

While operating in Dive or Gauge Mode, the audible alarm will emit 1 beep per second for 10 seconds when alarms strike, unless it is set to Off. During that time, the audible alarm can be acknowledged and silenced by pressing the SELECT button.

An LED warning light, on the side of the housing, is synchronized with the audible alarm and flashes as the audible alarm sounds. It will turn off when the alarm is silenced. The audible and LED alarms will not be active if the audible alarm is set to OFF (a Set Alarms setting).

Free Dive Modes have their own alarms which emit multiple beeps multiple times which cannot be acknowledged or set to OFF.

Events that emit (10) beeps >> each sound for ½ sec with ½ sec silence between beeps:

- Watch Daily Alarm.
- Watch CDT Alarm.
- DIVE, GAUGE - GTR Alarm.
- DIVE, GAUGE - Turn Alarm (TMT 1).
- DIVE, GAUGE - Press Alarm (TMT in use).
- DIVE, GAUGE - Loss of Link (Dive Mode).
- DIVE, GAUGE - Ascent Rate too fast.
- DIVE, GAUGE - Depth Alarm.
- DIVE, GAUGE - EDT Alarm.
- DIVE - DTR Alarm.
- DIVE - N2 Alarm.
- DIVE - entry into Decompression.
- DIVE - Conditional Violation.
- DIVE - Delayed Violations 1, 2.
- DIVE, GAUGE - Delayed Violation 3.
- DIVE, GAUGE - entry into Violation Gauge Mode.
- DIVE - PO2 Warning and Alarm.
- DIVE - O2 Warning and Alarm.
- DIVE - Gas Switch Alarm.

Events that emit (3) beeps >> each sound for ½ sec with ½ sec silence between beeps:

- DIVE, GAUGE - Ascent Rate warning.
- FREE - Delayed Violation 3.

Events that emit (3) sets of (3) beeps >> each sound for ½ sec with ½ sec silence between beeps and ½ sec silence between sets:

- FREE - SRT Alarm.
- FREE - RDI Alarm. RDI does not alarm at the DA alarm depths.
- FREE - CDT Alarm.
- FREE - N2 Alarm.
- FREE - Violation, entry into Decompression.

Events that emit (3) sets of (3) beeps >> each sound for ⅙ sec with ⅙ sec silence between beeps and ¼ sec silence between sets:

- FREE - DA1 to DA3 Alarms.

Events that emit (2) beeps >> each sound for 1 sec with ½ sec silence between beeps:

- FREE - RTI Alarm.

PROXIMITY OF THE TMTS (TRANSMITTERS) AND i450T

The TMTs emit low frequency signals that radiate out in semicircular patterns parallel to the length dimension of the TMT. A coiled antenna inside the i450T wrist unit receives the signals when it is positioned within a zone parallel to or at a 45 degree angle to the TMT as illustrated.

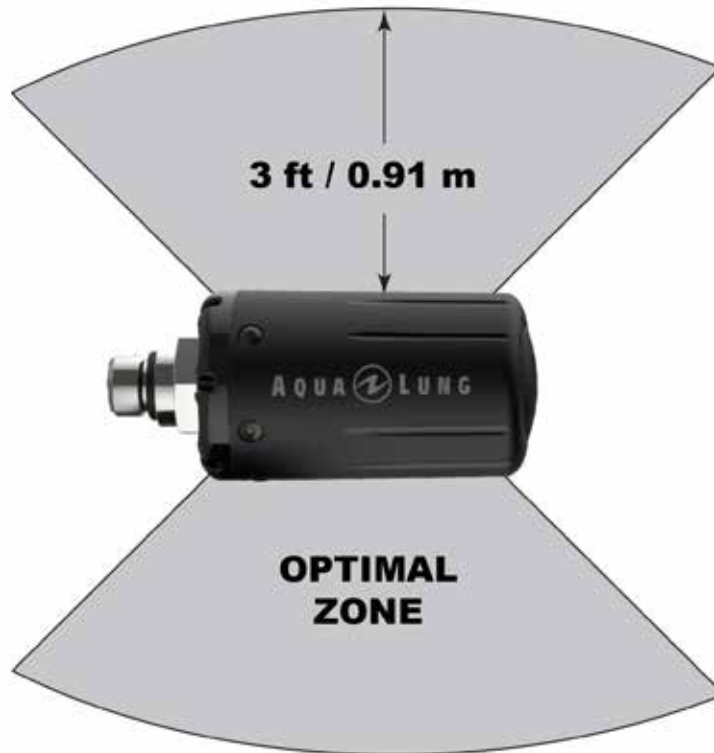

The i450T cannot effectively receive a signal when it is held out to the sides of the TMT or held at distances greater than 3 feet (0.91 meters) in front of the TMT. Best reception is achieved when the i450T is within less than 3 feet (0.91 meters) of the TMT.

When installed into the high pressure ports of the regulator first stages, the TMTs must be positioned so that they face horizontally outward from the tank valves.

Link Interruption Underwater

During a dive, you may at times move the i450T out of the signal pattern of the TMT, resulting in a temporary loss of the link signal. The link will be restored within 4 seconds after the i450T is moved back into its correct position.

An interruption may also occur while the i450T is within 3 feet (1 meter) of a running DPV, or shortly after a strobe flashes. The link will be restored within 4 seconds after the i450T is moved out of that area.

If the link is not restored within 15 seconds, the audible alarm will sound, dashes will replace GTR and gas pressure values, and the link icon will flash until it is restored.

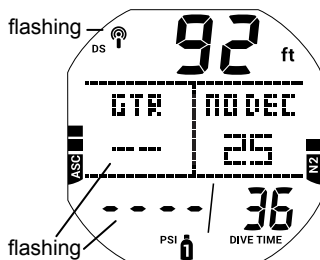



DIVE SURFACE MODE



ON THE SURFACE BEFORE A DIVE

The Dive Main screen will display the SURF-T (Surface Time) and the selected FO₂ of the breathing gas. The surface time displayed is the time since activation or the surface interval after a dive.

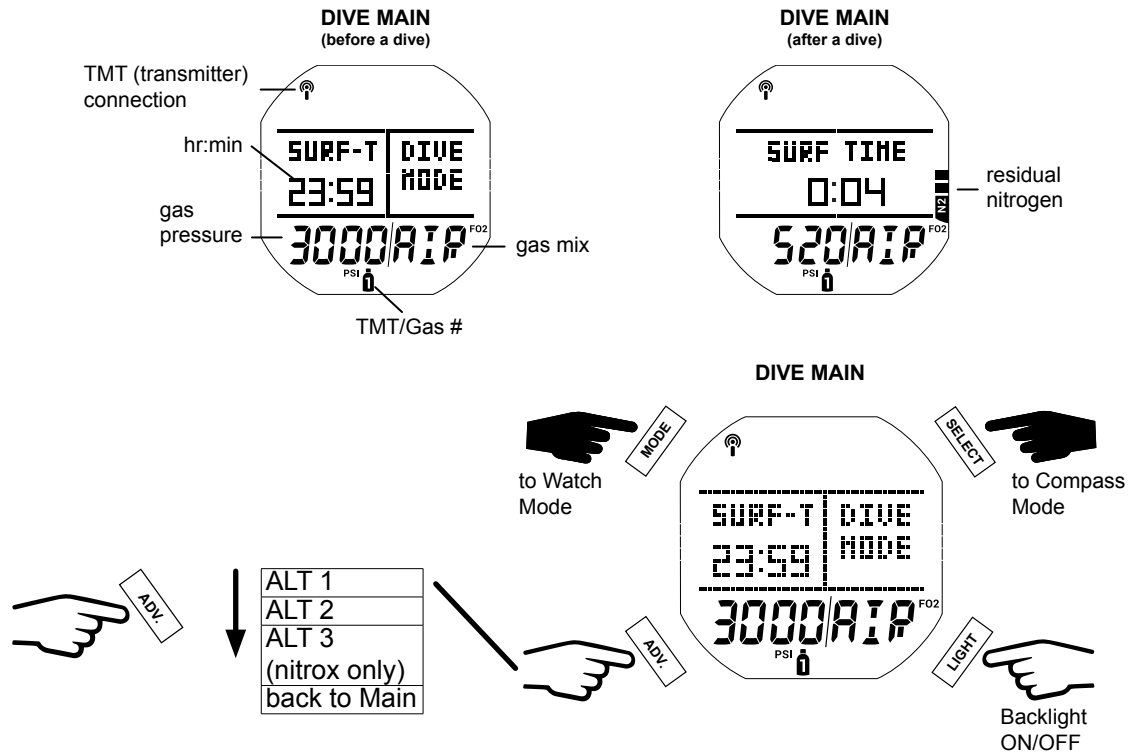

ALT 1 (LAST DIVE)

The ALT 1 screen displays essential data from the last dive. If there has been no dive within the current activation cycle, the dive number will display zero and dashes for the max depth and elapsed dive time will be displayed.

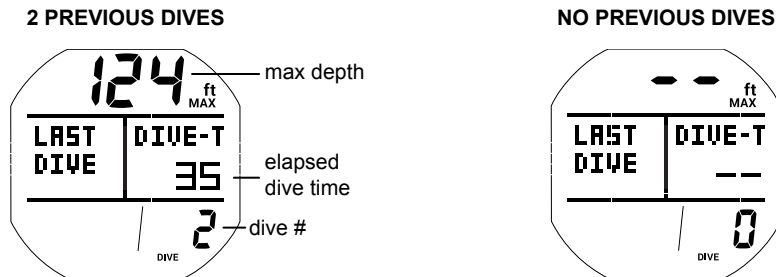

ALT 2

The ALT 2 screen displays current elevation readings, time of day, and temperature.



ALT 3

The ALT 3 screen displays only after a nitrox dive. It displays the current oxygen saturation level and the current gas mix.

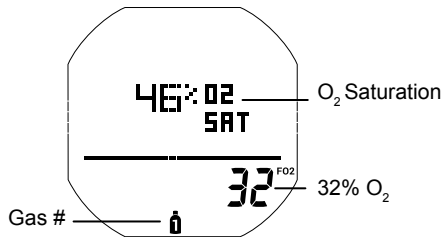

DIVE SURF MAIN MENU

To view i450T logs, change settings, or switch modes you must navigate through the Surf Main Menu. Enter the menu by pressing the MODE button. Some screens simply display data. While other screens are lead-ins to sub menus and settings. Press the SELECT button to choose menus or options from the Main Menu when available. All Main Menu screens and options will be discussed in the order they appear in the menu below.

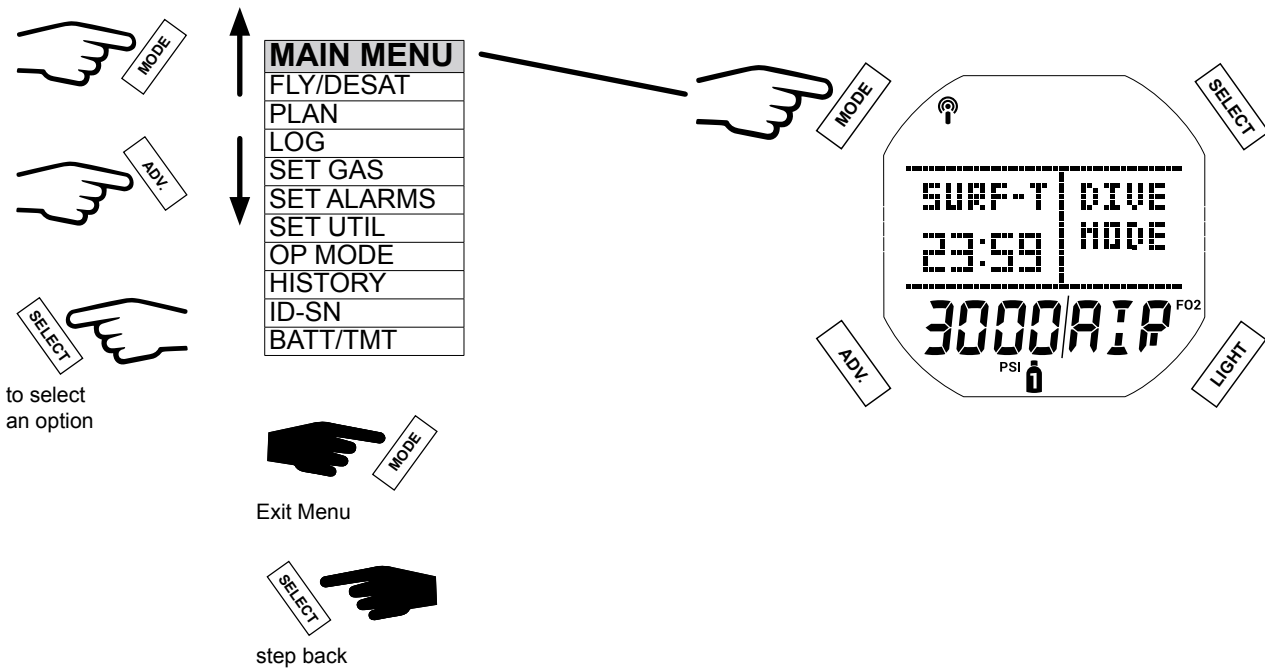

FLY/DESAT

The FLY/DESAT screen displays the Time to Fly and the DESAT (desaturation) countdown. The Time to Fly countdown shall begin counting from 23:50 to 0:00 (hr:min), 10 minutes after surfacing from a dive. The DESAT counter shall provide calculated time for Tissue Desaturation at sea level taking into consideration the CF (Conservative Factor) if it was set on. It shall begin counting down 10 minutes after surfacing from DIVE or FREE dives counting down from a maximum of 23 to 10 (hr only), then 9:59 to 0:00 (hr:min). When the DESAT countdown reaches 0:00 (hr:min), which will generally occur prior to the FLY countdown reaching 0:00 (hr:min), it will remain on the display as 0:00 until the Fly count down reaches 0:00.

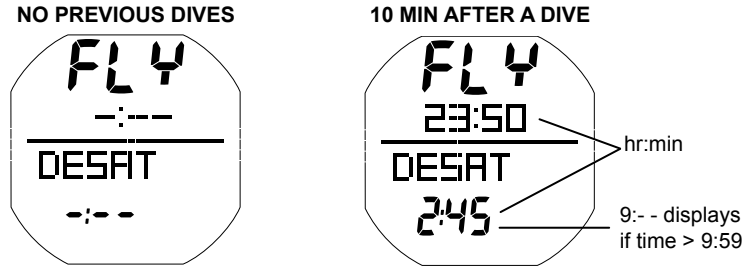

PLAN

This mode calculates dive depth and time limits. To do so, it accounts for any residual nitrogen, oxygen, surface intervals, the programmed gas mix, and PO₂ alarm setting. Either NO DEC (No Decompression) or O₂ MIN limits are displayed, depending on whether nitrogen or oxygen levels will be the limiting factor. The time limit will display as 1-99 minutes, all times greater than 99 display as 99.

NOTE: Depths exceeding the MOD (Maximum Operating Depth), if nitrox, or that have less than 1 minute allowed dive time will not be displayed.

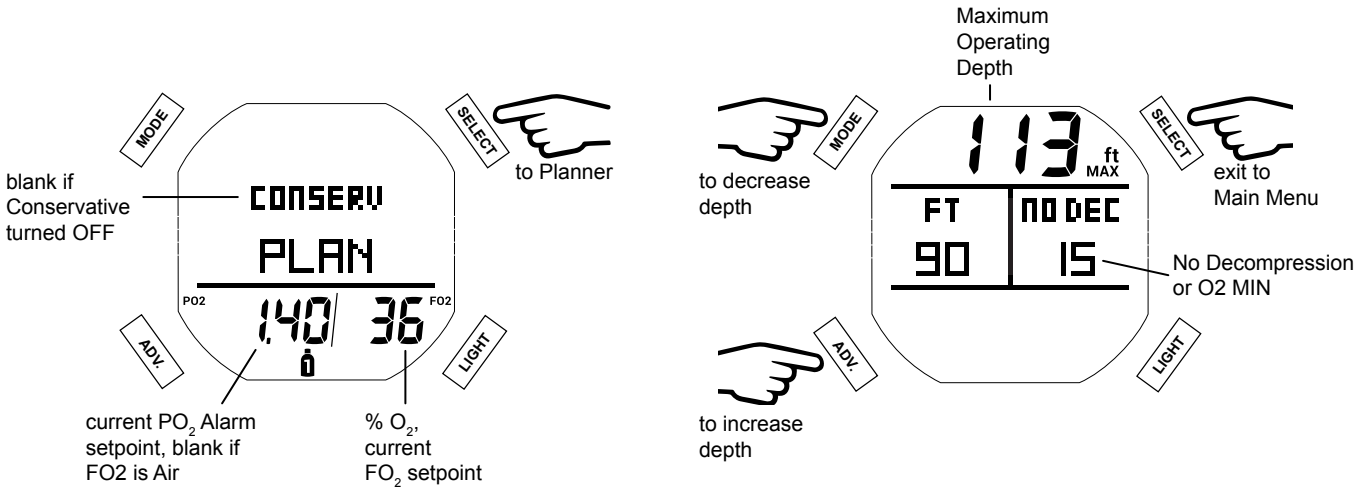

LOG

The log stores Information from the latest 24 DIVE and/or GAUGE mode dives for viewing.

- If no dives are recorded, the message NO DIVES YET will be displayed.
- After exceeding 24 dives, the most recent dive is stored while the oldest is deleted.
- Dives are numbered from 1 to 24 starting each time a dive is activated in either Dive (or Gauge) mode. After the post dive 24 hour period has elapsed and the unit shuts off, the first dive of the next activation period will be recorded as dive #1.
- In the event that dive time (DIVE MIN) exceeds 999 min, the data at the 999 interval is recorded in the Log upon surfacing of the unit.
- The message GAUGE or VIOL (violation) will display, above the dive start time, if applicable on the Log Data 1.

NOTE: New data will automatically overwrite the oldest data in memory when the memory becomes full. If you do not remember to log or download your dives, they will be lost when the memory overwrites. See the PC Download section of this manual for instructions on downloading dives.

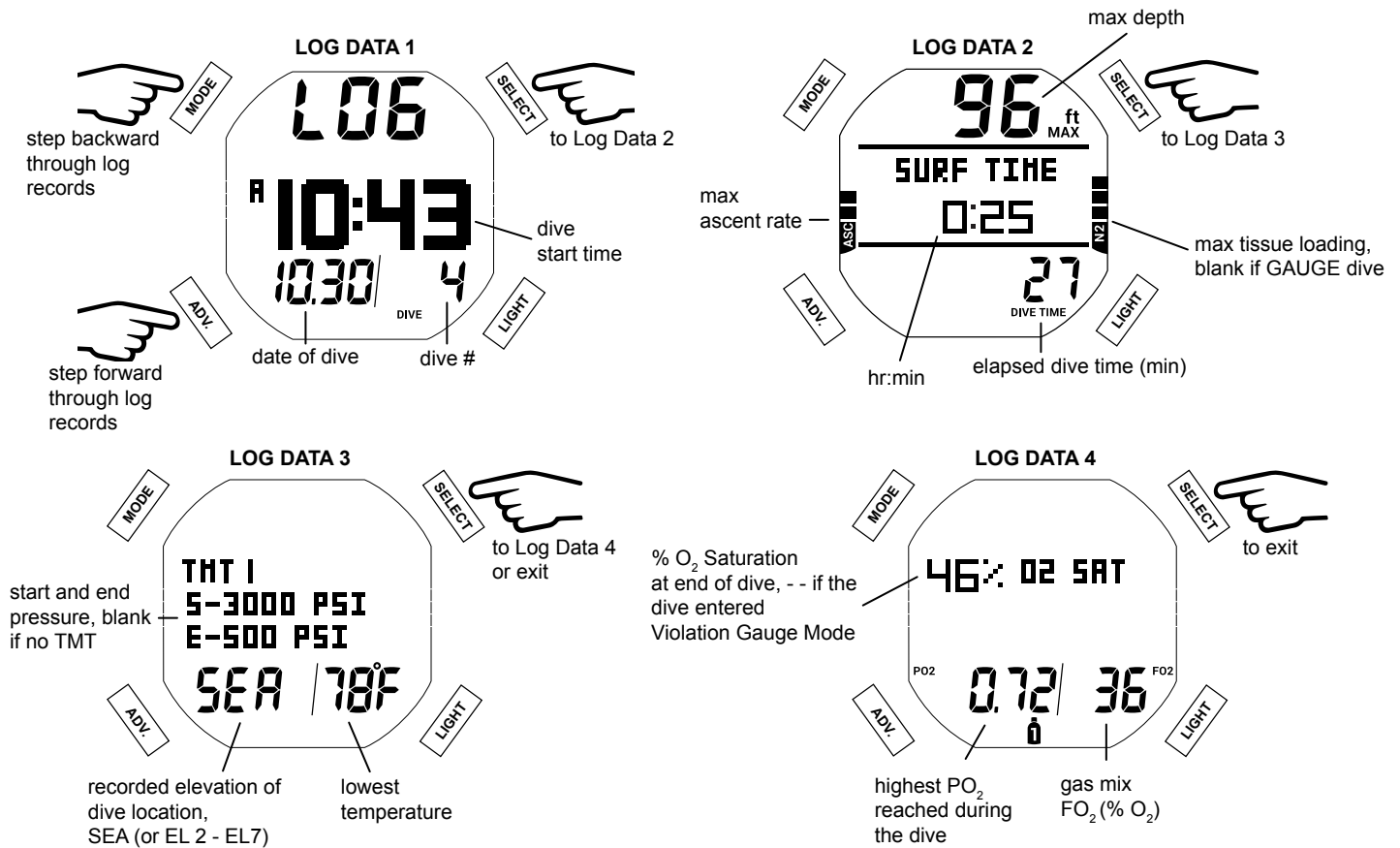

NOTE: Log Data 4 only displays for nitrox dives; it is bypassed if the dive was an air dive.

SET GAS

Within this submenu you can change the three available gas mixes from air to any nitrox mix between 21 - 100 FO₂ (% O₂). Nitrox mixes are displayed with their corresponding MOD (Maximum Operating Depth) and the current PO₂ Alarm setting for the selected gas. Default settings are FO₂ AIR with no PO₂ alarm value for Gas 1, and OFF for Gas 2 and 3. Settings revert to the defaults when 24 hours elapse without conducting a dive. If you set a nitrox mix value for any gas the PO₂ alarm value will default to 1.40 until changed. Additionally, the i450T allows for each gas (1 - 3) to have individual PO₂ alarm settings.

NOTE: Once any Gas is set for Nitrox, any other Gas set for AIR will automatically be set to 21%. The AIR option will not be displayed as an FO₂ setting until 24 hours elapse after the last dive.

NOTE: When FO₂ is set for AIR, oxygen related data (such as PO₂, % O₂) will not be displayed at any time during the dive, on the surface, or in Plan Mode. Though these oxygen values will be tracked internally for use in any subsequent nitrox dives.

NOTE: Gas 1 cannot be set to OFF.

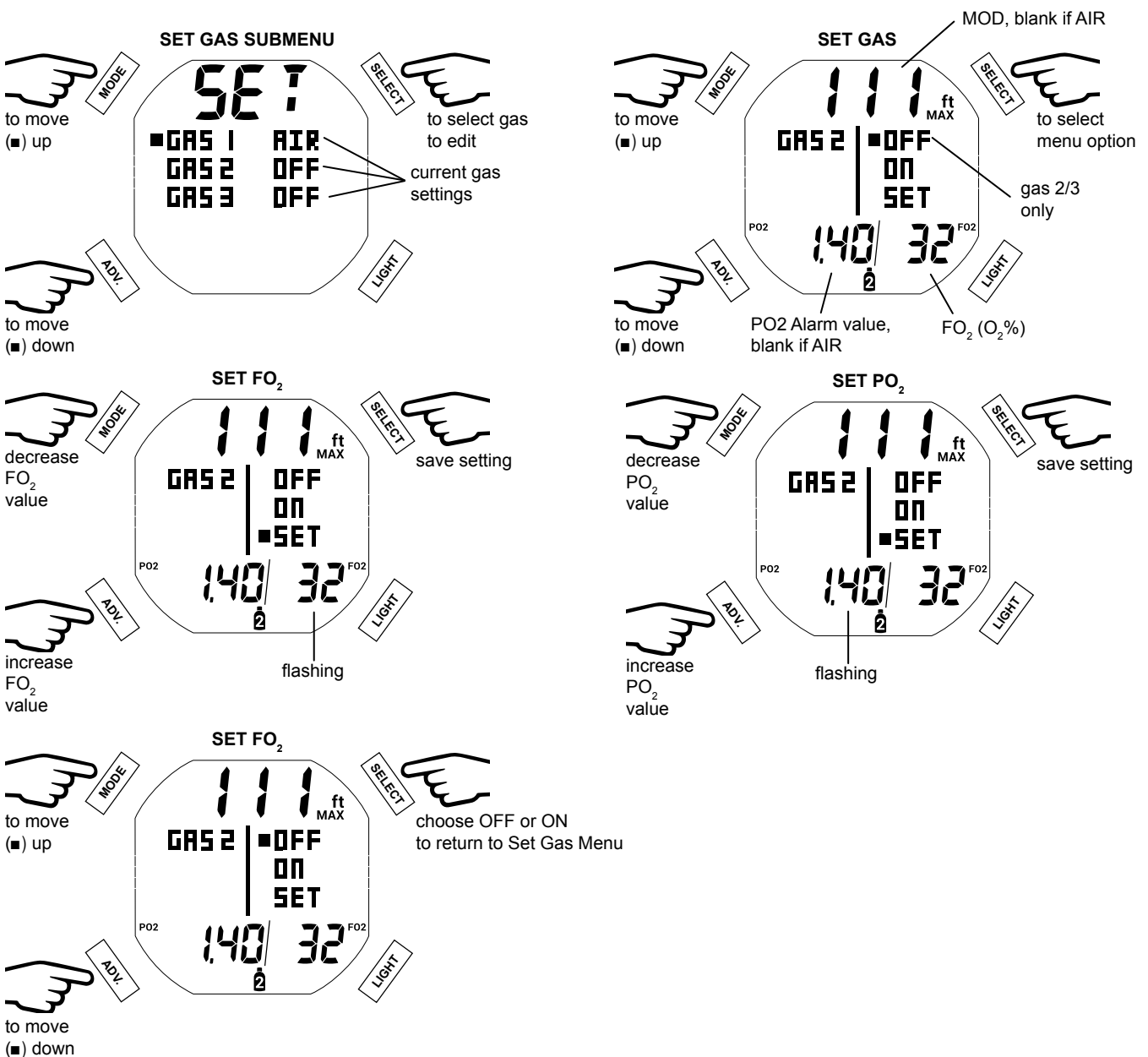

SET AL (ALARMS)

Within this submenu you can customize the following seven alarm settings.

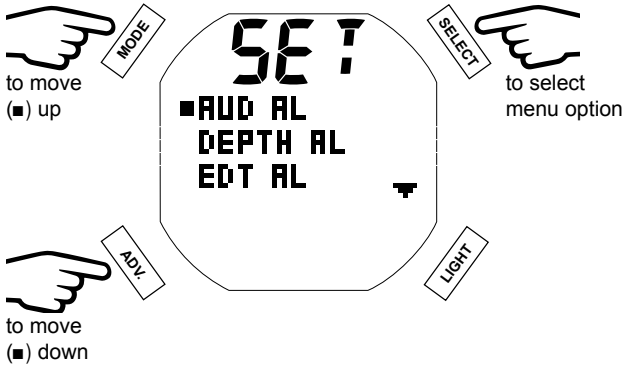

1. AUD AL (Audible Alarms)

The Audible Alarm feature allows you to set audible alarms ON or OFF.

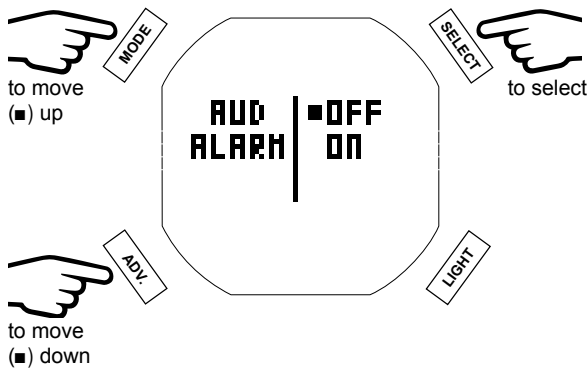

2. DEPTH AL (Audible Alarms)

The Depth Alarm feature allows you to set a maximum depth alarm of 30 - 330 ft (10 - 100 m).

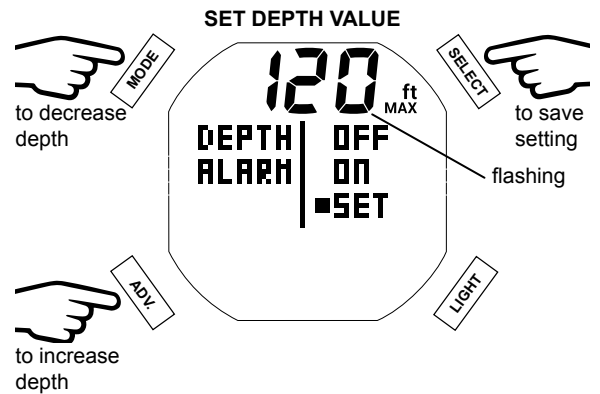
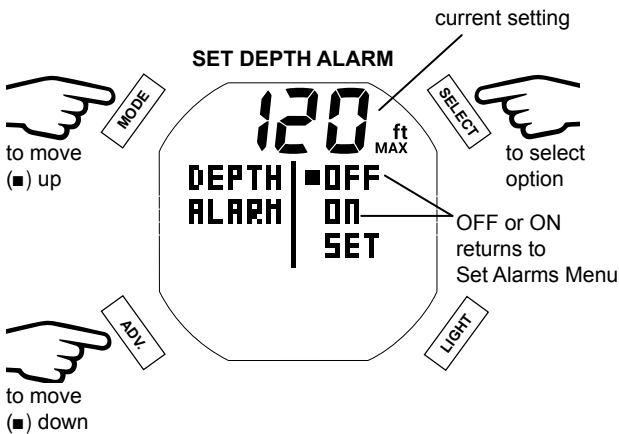

DEPTH AL TRIGGERED

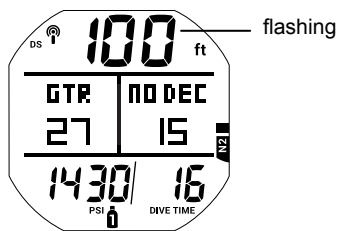

3. EDT AL (Elapsed Dive Time Alarm)

This feature allows you to set an alarm to go off at a predetermined amount of dive time (10 - 180 min).

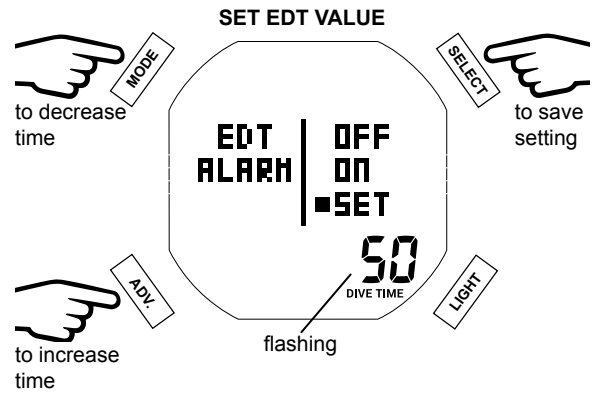
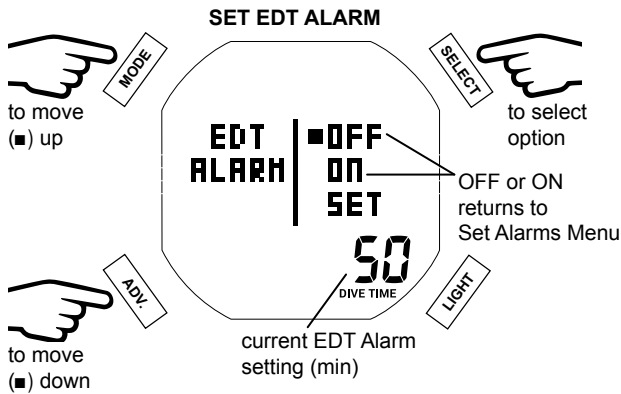

EDT AL TRIGGERED

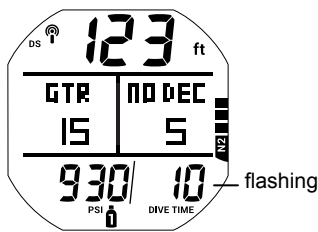

4. N2 AL (Nitrogen Alarm)

This feature allows you to set an alarm to go off at a predetermined number of N2 bar graph segments.

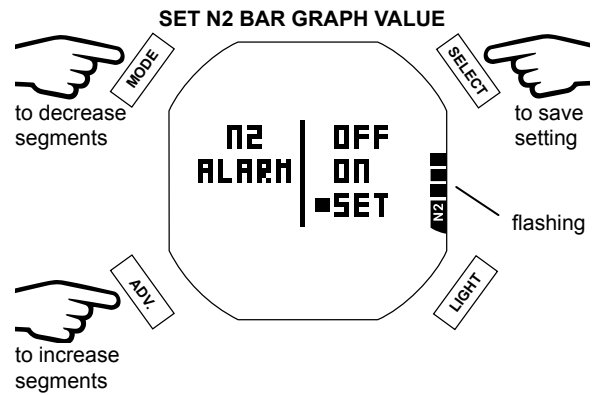
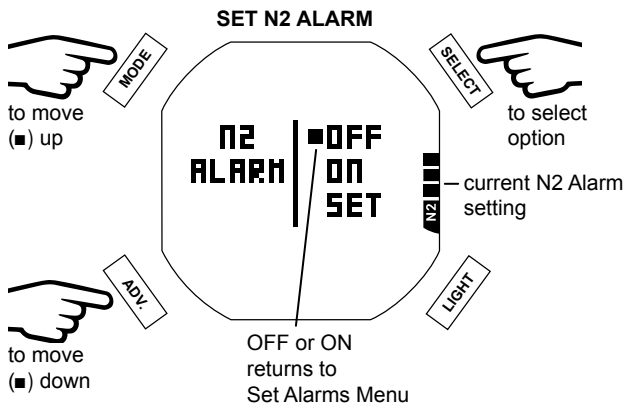

N2 AL TRIGGERED

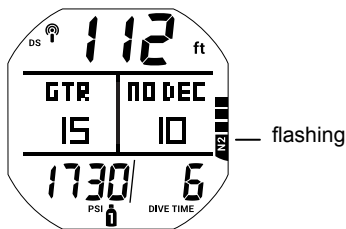

5. DTR AL (Dive Time Remaining Alarm)

This feature allows you to set an alarm to go off with a designated reserve (5 - 20 min) of dive time remaining.

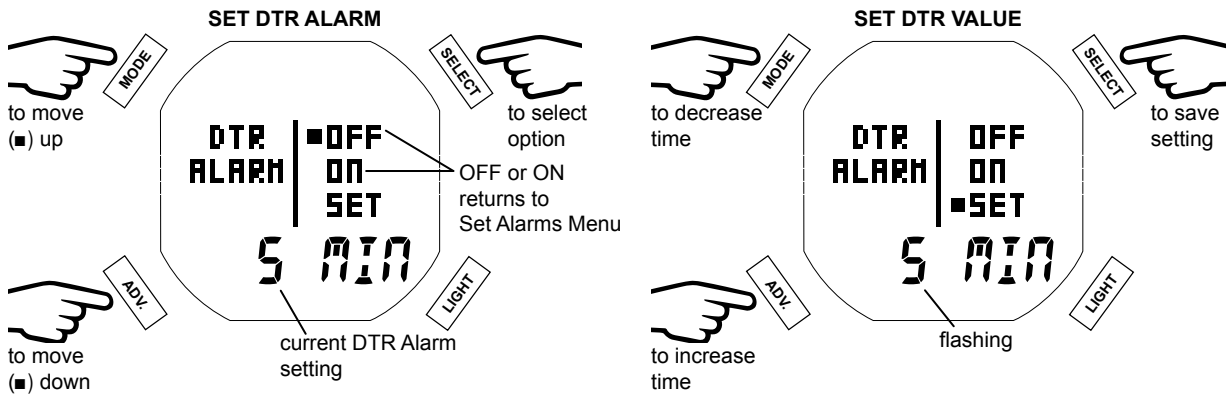

DTR AL TRIGGERED

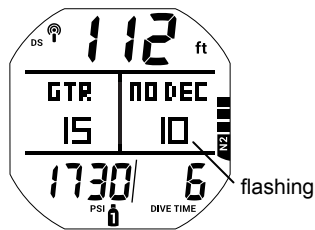

6. TURN AL (Turn Pressure Alarm)

This feature allows you to set an alarm to go off at a designated turn pressure. You may choose from 1000 to 3000 PSI (70 to 205 BAR) in increments of 250 PSI (5 BAR).

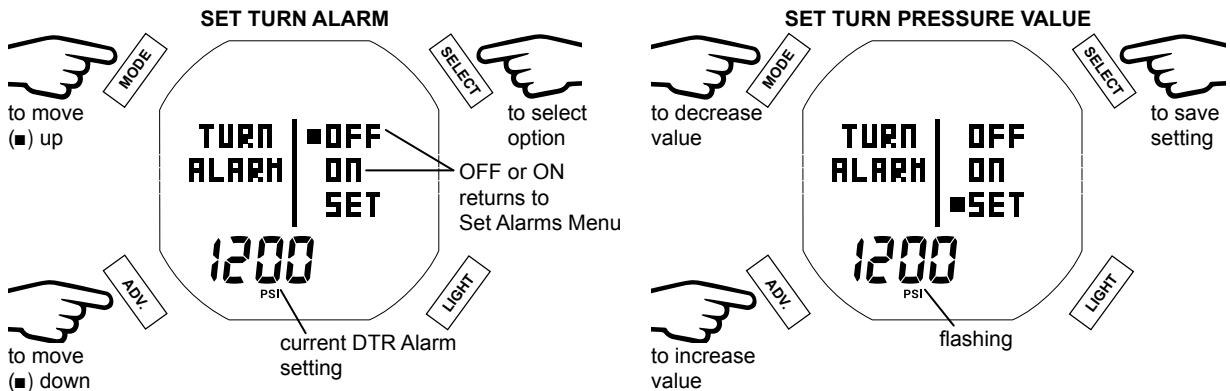

TURN AL TRIGGERED

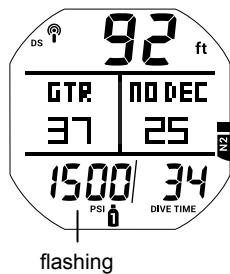

7. PRESS AL (Pressure Alarm)

This feature allows you to set an alarm for when you reach a designated end pressure. You may choose from from 300 to 1500 PSI (20 to 105 BAR) in increments of 100 PSI (5 BAR).

NOTE: The Pressure Alarm only considers the active gas when diving with multiple gas transmitters.

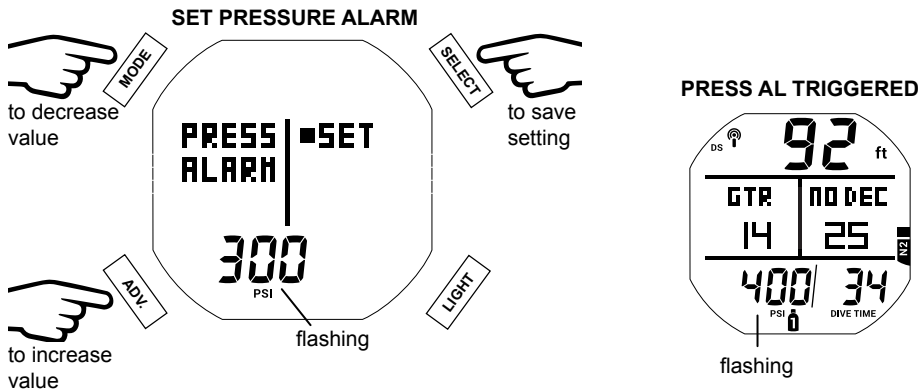

SET UTIL (UTILITIES)

Within the Set Util menu you can customize the following nine operational functions.

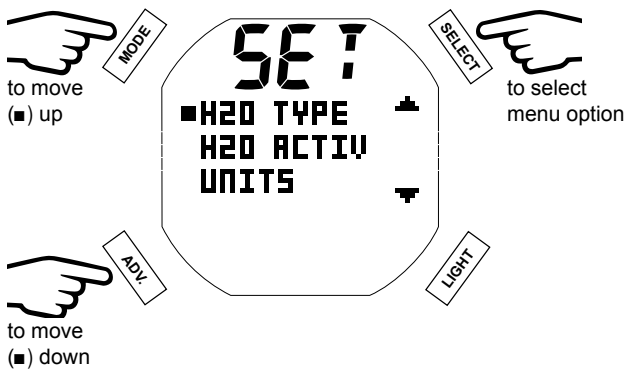

1. H2O TYPE (Water Type)

The H2O Type feature allows you to set SALT or FRSH (fresh) water environment for accurate depth calculations.

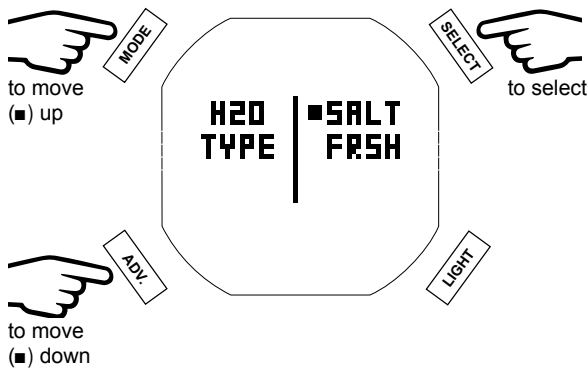

2. H2O ACTIV (Water Activation)

The H2O ACT feature allows you to turn OFF water contact activation.

⚠ WARNING: With H2O ACT turned OFF, you **MUST** remember to manually activate the Dive Mode before any dive.

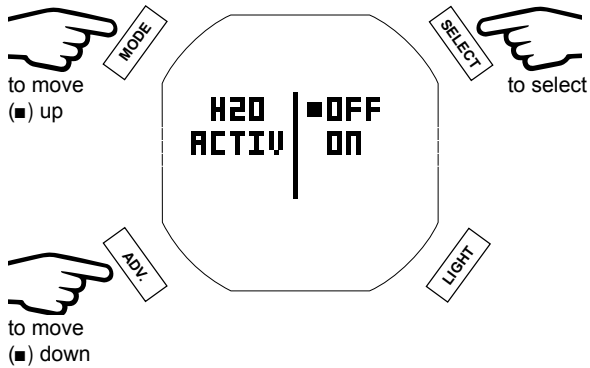

3. UNITS (IMP/MET)

The Units feature allows you to select whether IMP (imperial) or MET (metric) units of measure will be displayed.

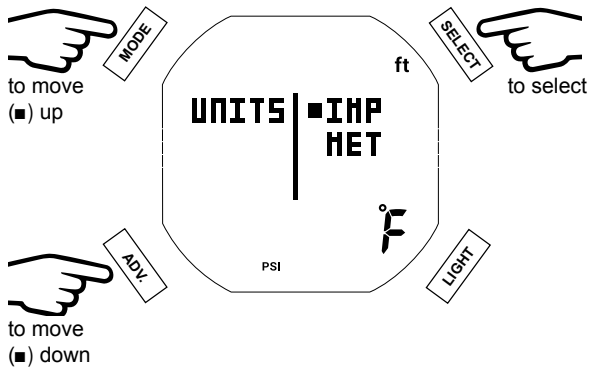

4. DEEP STOP

The Deep Stop feature can be set ON or OFF.

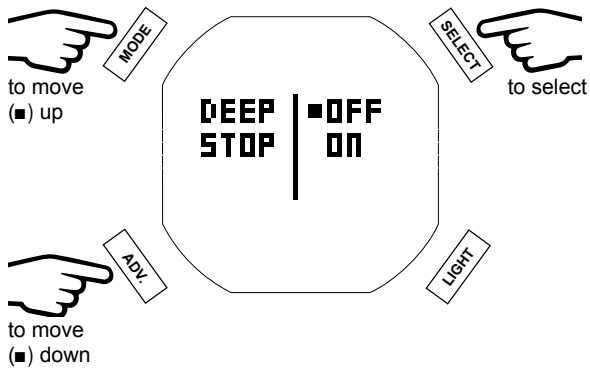

5. SAFE STOP (SAFETY STOP)

The Safety Stop feature can be set ON or OFF. If ON is selected, you may choose from an available 3 or 5 min Safety Stop at depths of 10, 15, or 20 ft (3, 4, 5, or 6 m).

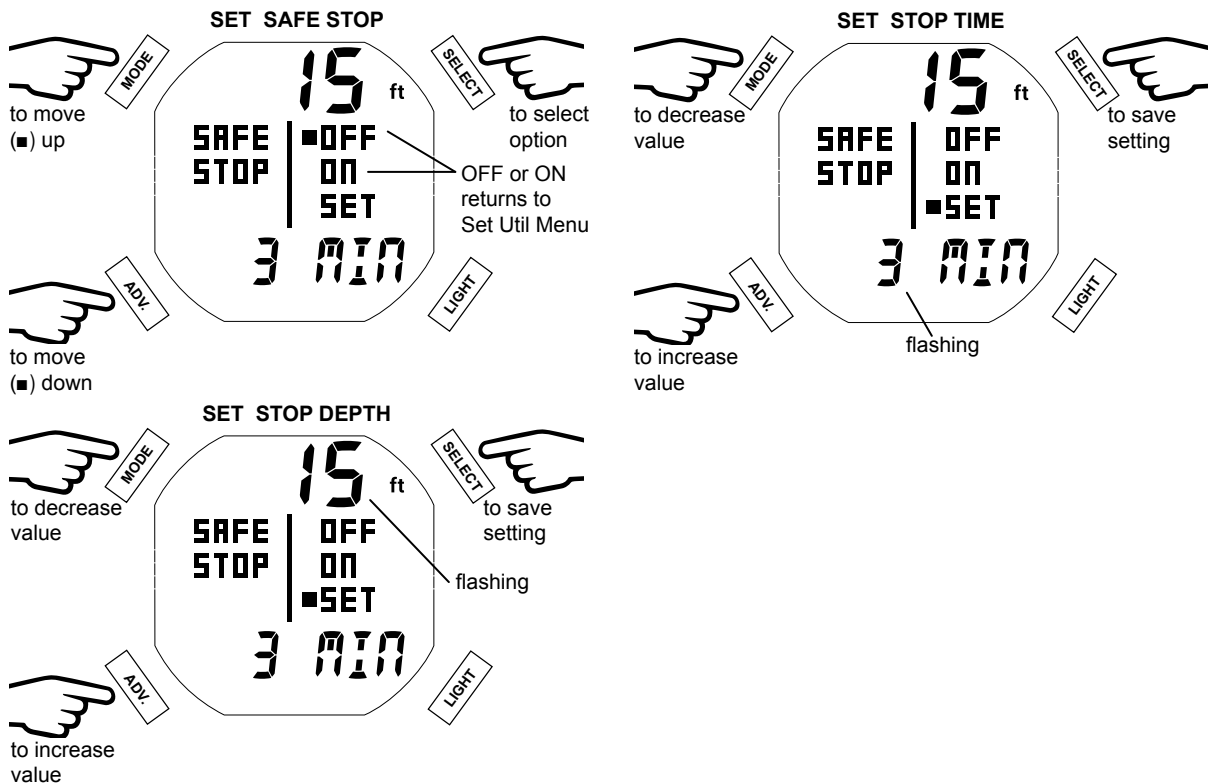

6. CONSERV (Conservative Factor)

The Conservative feature can be set ON or OFF.

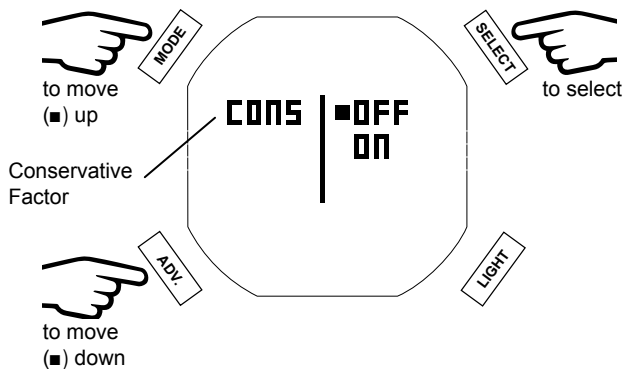

7. LIGHT DURA (DURATION)

This setting is the duration the backlight stays on after releasing the buttons. The options are OFF, 5, 10, 30, or 60 sec.

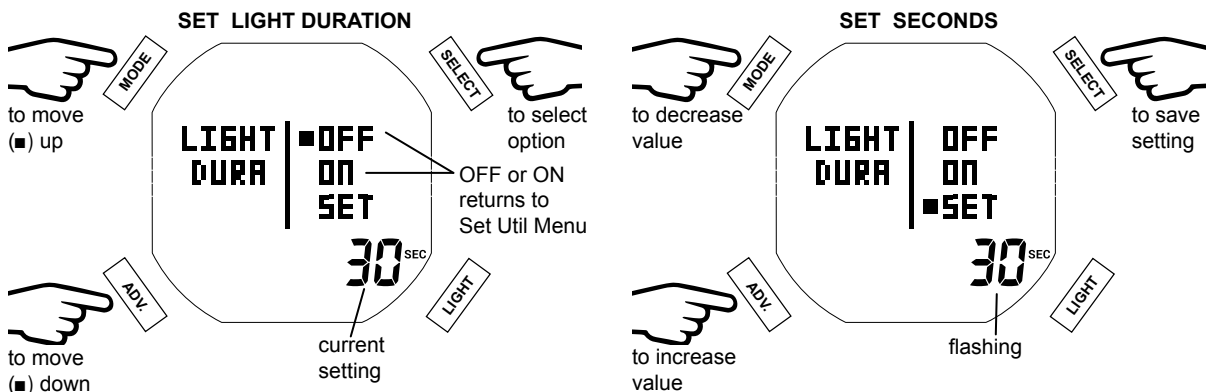

8. SAMPLING (SAMPLE RATE)

The Sample Rate controls how frequently the i450T stores a data snapshot for PC Download during a dive. Setting options are 2, 15, 30, or 60 second intervals. Shorter intervals will provide a more precise record of your dives.

NOTE: New data will automatically overwrite the oldest data in memory when the memory becomes full. The i450T Log and PC Download data is stored separately in different partitions of the memory. The Log only stores a short summary of each dive. Alternately, the PC Download function stores much larger files for each dive. Depending on the chosen settings and dive durations, it is possible to see dives stored in the i450T's onboard Log that have already been overwritten in the PC Download Partition. Choosing a longer Sample Rate interval will consume less memory per dive. Remember to download your dives more frequently if you are using a shorter Sample Rate interval.

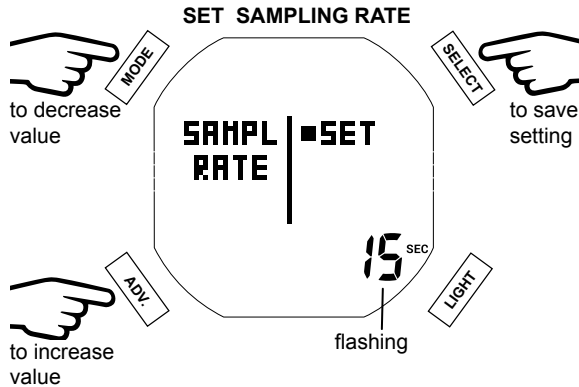

9. TMT MENU (TRANSMITTER MENU)

The i450T can use up to 3 transmitters to monitor gas supplies. The TMT Menu allows for the programming of the wrist unit to receive the signals from selected Aqua Lung transmitters. See the Dive Mode Features section (p. 24) for further information on transmitters.

NOTE: If the TMT is set OFF for the active gas, the letters SPG will be displayed in place of a pressure reading on the Main Screen.

NOTE: Transmitter 2 cannot be set to ON unless transmitter 1 is set to ON. Likewise, transmitter 3 cannot be set to ON unless transmitter 2 is also set ON. If you attempt to do so, the i450T will display the message TMT 1(2) MUST BE SET ON FIRST.

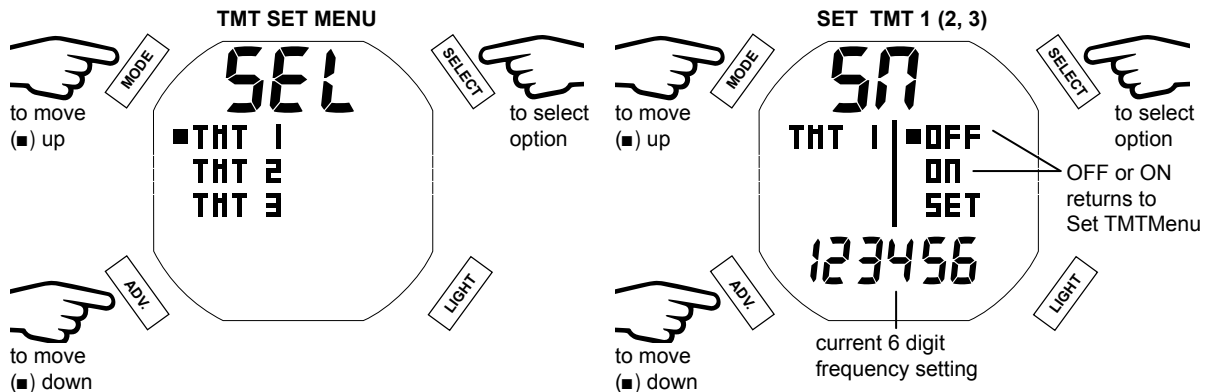

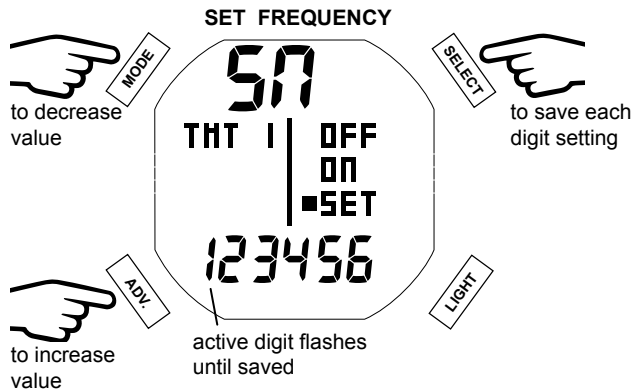

NOTE: The serial number can be located in two places directly on the transmitter (see below).



OP MODE (OPERATION MODE)

Op Mode allows you to choose between DIVE (standard recreational dive), GAUGE, and FREE (free diving) modes of operation.

NOTE: Once a dive is conducted in GAUGE Mode, the i450T shall operate with limited functions without any decompression or oxygen monitoring functions. A 24 hour surface interval shall be required for the unit to operate as a full function DC in DIVE or in FREE Mode.

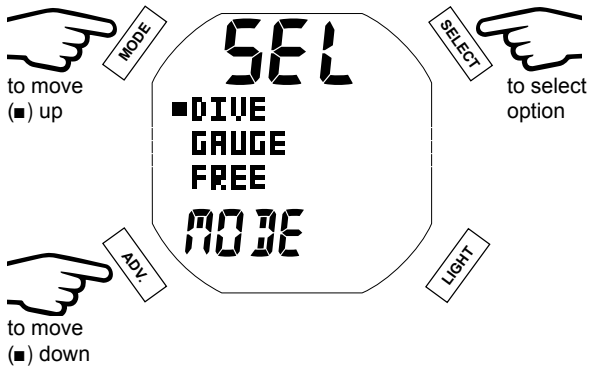

HISTORY

History is a summary of basic data recorded during all diVE and GAUGE dives.

NOTE: Dives made in Free mode are not shown in History or the Log Mode. Free dive data is only visible using the PC Download software.

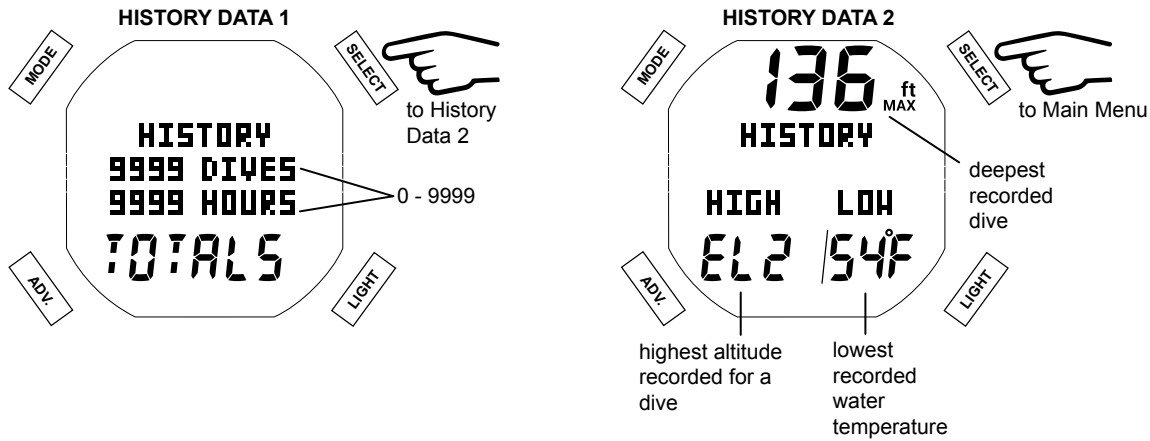

ID-SN (SERIAL NUMBER)

Information displayed on the Serial Number screen should be recorded and kept with your sales receipt; it will be required in the event that your i450T requires factory service.

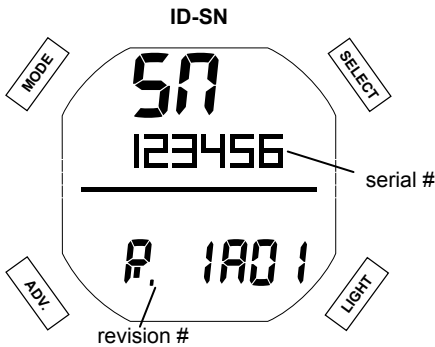

BATT/TMT (BATTERY/TRANSMITTER STATUS)

This screen checks battery and connection status for the wrist module and transmitters. It will show the battery status of the i450T wrist module first. Then it will automatically cycle through any active transmitters before returning to the Main Menu.

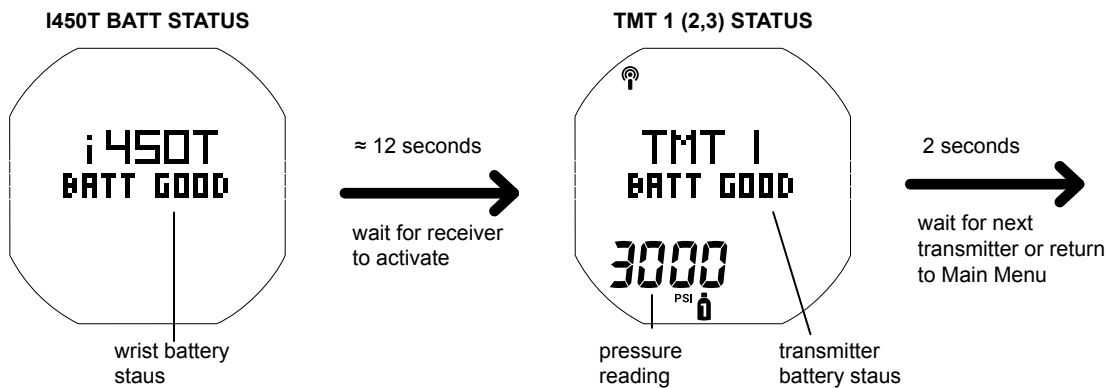

DIVE OPERATION

INITIATING A DIVE

With the i450T in Dive Mode, a dive will commence upon descending to 5 ft (1.5 m) for at least 5 seconds. Below is a diagram to help you navigate Dive Mode functions.

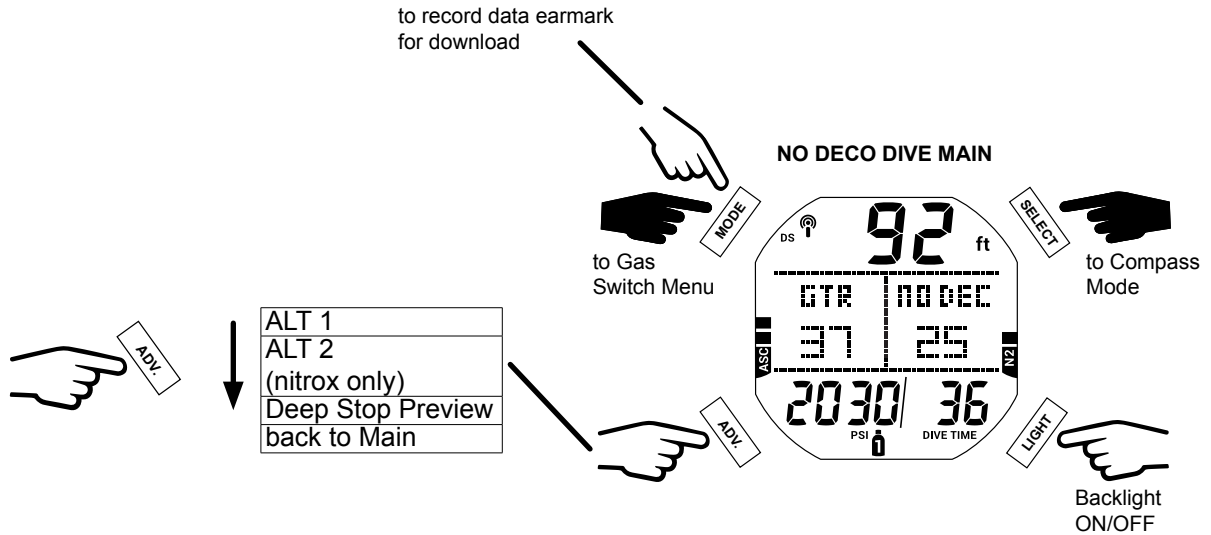

NO DECOMPRESSION DIVE MAIN

From the Main screen you can see all critical dive parameters. During a dive an audible alarm may sound and the priority of information displayed may change. This is to indicate a safety recommendation, warning, or alarm. The following information in this chapter demonstrates and describes an uneventful dive, in terms of safety. Alarms are described in the Complications section of this chapter.

⚠ WARNING: Before diving with the i450T take time to familiarize yourself with both normal and alarm conditions of operation.

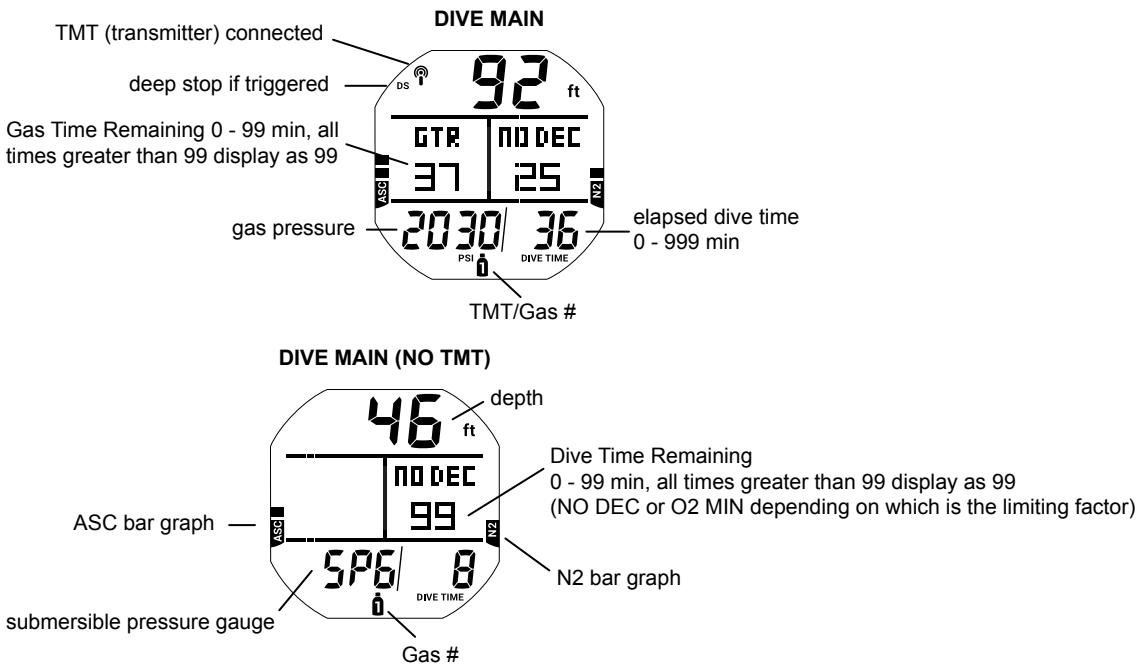

DIVE ALT 1

This screen simply tells you the max depth, current time of day, and ambient temperature.

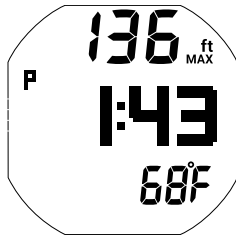

DIVE ALT 2

The ALT 2 screen displays information pertaining to nitrox; it is bypassed if the i450T is set for air.

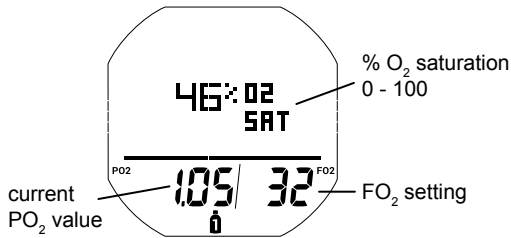

DEEP STOP PREVIEW

If Deep Stop was set to ON in the UTIL Menu, the Deep Stop preview screen is available after exceeding 80 ft (24 m) of depth. The Deep Stop is always at a depth half that of your maximum depth during the dive. This preview screen keeps track of that depth for you.

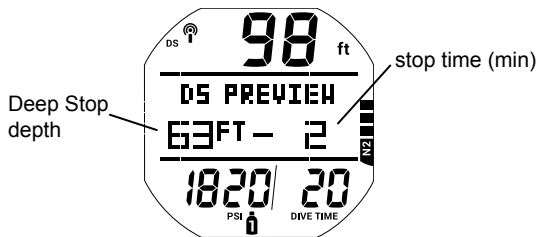

EARMARK

By pressing the Mode button during a dive you can manually record a data snapshot which can later be accessed using the i450T's download feature. The message "EARMARK APPLIED" will be displayed for 3 seconds as confirmation after an earmark is made.

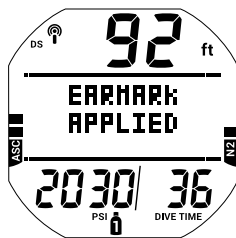

DEEP STOP MAIN

If triggered, the Deep Stop will activate upon ascending to within 10 ft (3 m) below the calculated Deep Stop depth. The stop time will be displayed and count down to 0 min as long as you stay within 10 ft (3 m) above or below the stop. While Deep Stop Main is displayed, you may access up to 3 ALT displays by pressing the ADV button to cycle through them. They are similar to the No Decompression Main, Dive ALT 1, and Dive ALT 2 displays, respectively. See Deep Stop in the Dive Features chapter for further details.

NOTE: The i450T does not penalize for a missed Deep Stop.

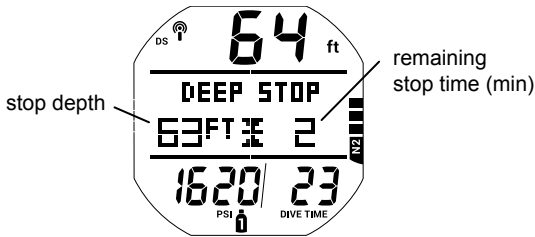

SAFETY STOP MAIN

If triggered, the Safety Stop will activate upon ascent to within 5 ft (1.5 m) deeper than the Safety Stop depth on a No Deco dive. The stop time will then countdown to 0 min. While Safety Stop Main is displayed, you may access up to 3 ALT displays by pressing the ADV button repeatedly. They are similar to the No Deco Main, Dive ALT 1, and Dive ALT 2 displays, respectively. See Safety Stop in the Dive Features chapter for further details.

NOTE: The i450T does not penalize for a missed Safety Stop.

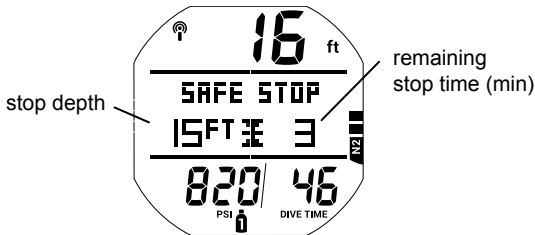

SURFACING

Upon ascending to 3 ft (0.9 m) the i450T transitions to Dive Surface mode.

NOTE: The i450T requires a 10 minute surface interval to record a subsequent dive as a separate dive in the Log. Otherwise, the dives will be combined and recorded as a single dive in the i450T memory.

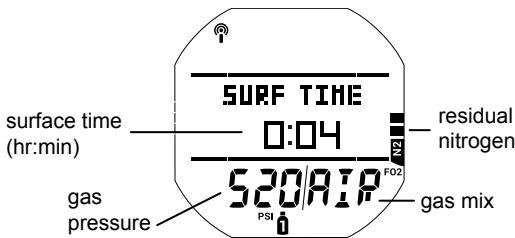

GAS/TRANSMITTER SWITCHES

⚠ WARNINGS:

- Historically, many accidents and near misses have occurred by switching to the wrong gas at the wrong depth. **DO NOT** attempt gas switch decompression dives without proper education and training to do so from an internationally recognized training agency.
- Diving deeper than 130 FT (39 M), will greatly increase your risk of decompression sickness.
- Decompression diving is inherently hazardous and greatly increases your risk of decompression sickness, even when performed according to the dive computer's calculations.
- Using an i450T is no guarantee of avoiding decompression sickness.
- The i450T enters Violation Mode when a situation exceeds its capacity to predict an ascent procedure. These dives represent gross excursions into decompression that are beyond the boundaries and spirit of the i450T's design. If you are following these dive profiles, Aqua Lung advises that you should not use an i450T.
- If you exceed certain limits, the i450T will not be able to help you get safely back to the surface. These situations exceed tested limits and can result in loss of some functions for 24 hours after the dive in which a violation occurred.

OVERVIEW

- All dives begin with GAS 1 and TMT 1.
- The GAS and TMT default to # 1 after 10 minutes on the surface.
- Gas switches can only be made when a Dive Main screen is displayed.
- Gases cannot be switched while on the surface.
- The Gas Switch Menu cannot be accessed during the sounding of alarms.
- If an alarm strikes while in the Gas Switch Menu, the switch operation is terminated (reverting to the Dive Main screen).

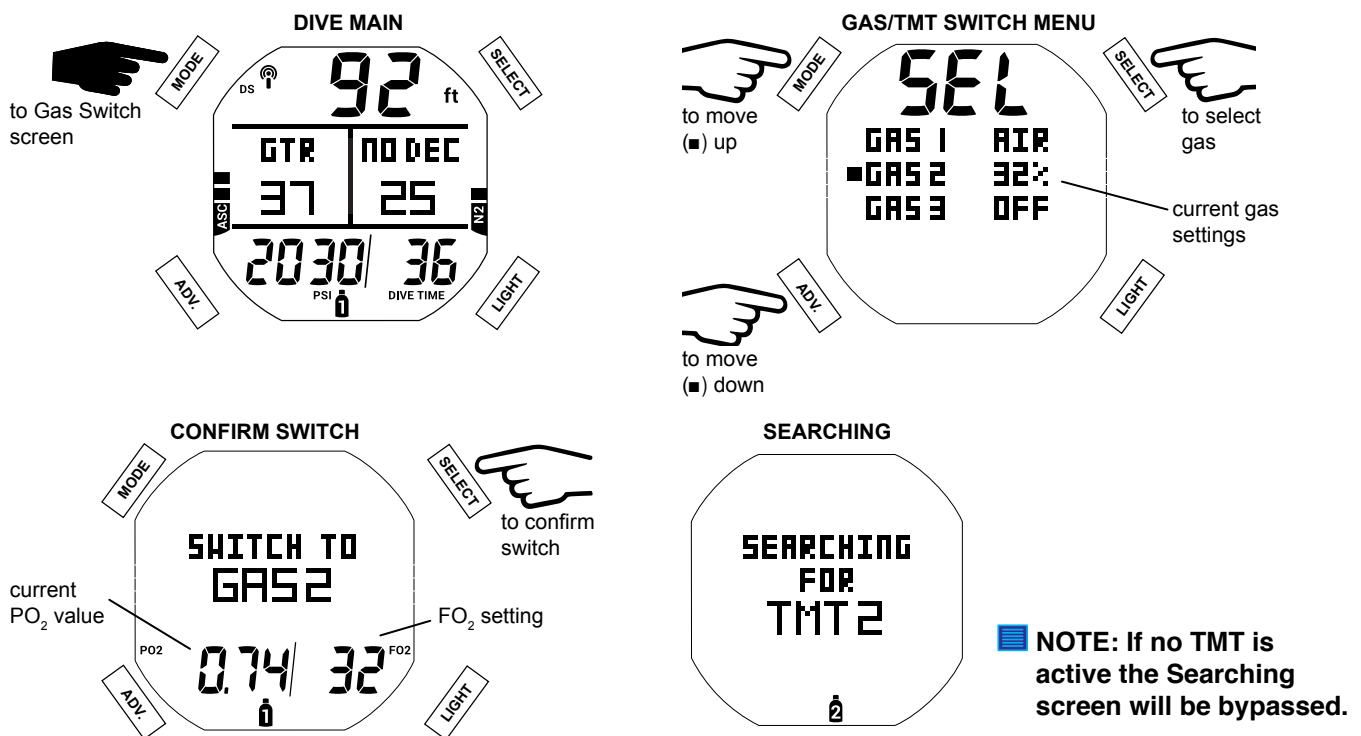

If the TMT is not reporting, a message will be displayed for 10 seconds before switching gas. Afterwards, the i450T will calculate for the gas change but the Dive Main screen will show a lost transmitter signal.

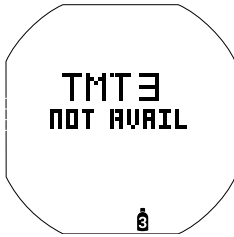

If the current PO_2 value is greater than 1.6, then a warning not to switch will display. The i450T will maintain the current gas without switching. The diver may override the i450T and force the gas switch by pressing the SELECT button during the DO NOT SWITCH TO message.

⚠ WARNING: Switching to gases with a PO_2 above 1.6 has a high risk of oxygen poisoning, convulsions, and drowning. Doing so should always be avoided. It is intended as a last resort option because of the likelihood of injury or drowning. Always dive within your training, experience, and skill level.



COMPLICATIONS

The preceding information has described standard dive operations. Your new i450T is also designed to help you to the surface in less than ideal situations. The following is a description of these situations. Take some time to familiarize yourself with these operations before diving your i450T.

DECOMPRESSION

Decompression (deco) mode activates when theoretical No Decompression time and depth limits are exceeded. Upon entry into deco, the audible alarm will sound and the alarm LED will flash. The full N2 bar Graph and Up Arrow icon will flash until the audible is silenced.

- Once within 10 FT (3 M) below the required Stop Depth (stop zone), the Full Stop icon (both Arrows with Stop Bar) will be displayed solid.

To fulfill your decompression obligation, you should make a safe controlled ascent to a depth slightly deeper than, or equal to, the required stop depth indicated and decompress for the stop time indicated. The amount of decompression credit time that you receive is dependent on Depth, with slightly less credit given the deeper you are below the Stop Depth indicated. You should stay slightly deeper than the required Stop Depth indicated until the next shallower Stop Depth appears. Then you can slowly ascend to that indicated Stop Depth but not shallower.

DECOMPRESSION ENTRY

Upon entry into decompression (deco) the audible alarm will sound and the alarm LED will flash until the audible is silenced. The message DECO, up arrows, and full N2 Bar Graph icons will flash. Additionally, the stop depth, stop time, and the TTS (Time To Surface) values will be displayed. TTS includes stop times at all required Deco Stops plus vertical ascent time based on the max ascent rate allowed.

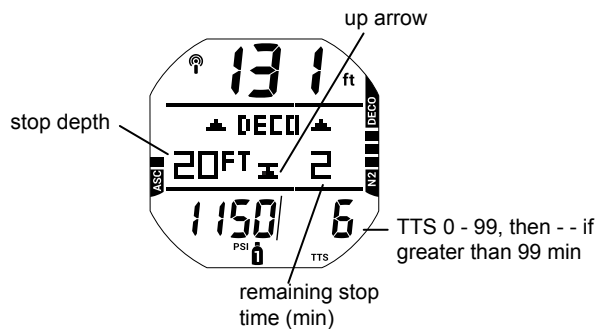

DECOMPRESSION STOP MAIN

Decompression (deco) Stop Main will display upon ascending to within 10 ft (3 m) below the Deco Stop depth. The message DECO STOP, the full stop graphic (opposed arrows with stop bar) will be displayed solid. While Deco Stop Main is displayed, you may access up to 3 ALT displays by pressing the ADV button to cycle through them. They are similar to the No Deco Main, Dive ALT 1, and Dive ALT 2 displays, respectively.

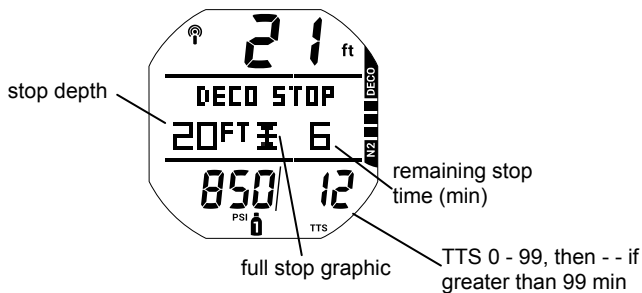

CONDITIONAL VIOLATION (CV)

Upon ascent above the required Decompression (deco) Stop depth, operation will enter Conditional Violation during which time no off gassing credit will be given.

The Audible alarm will sound and the alarm LED will flash. The full N2 Bar Graph, down arrows, and DOWN message will flash until the audible alarm is silenced, then the N2 Bar Graph will be solid.

- The down arrows continues to flash until descending below the required Stop Depth (within stop zone), then the full stop graphic (opposed arrows with stop bar) will be on solid.
- If you descend deeper than the required Decompression Stop before 5 minutes elapse, Decompression operation will continue with no off gassing credit given for time above the Stop. Instead, for each minute above the Stop 1½ minutes of penalty time will be added to the required Stop Time.
- The added penalty (decompression) time will have to be worked off before obtaining off gassing credit.
- Once the penalty time is worked off, and off gassing credit begins, required Decompression Stop Depths and Time will decrease toward zero. The N2 Bar Graph will recede into the No Decompression zone, and operation will revert to No Decompression mode.

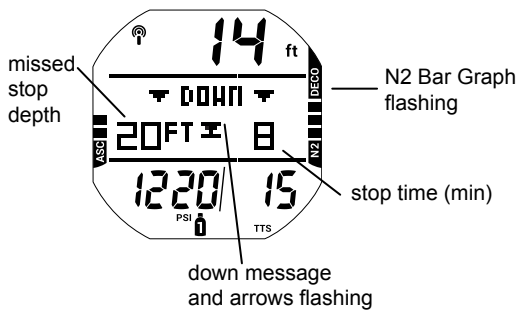

DELAYED VIOLATION 1 (DV 1)

If you remain shallower than a Deco Stop Depth for more than 5 minutes, operation will enter DV1* which is a continuation of CV with penalty time still being added. Again, the audible alarm will sound and the full N2 Bar Graph will flash until it is silenced. ALT screens are accessed and appear similar to Deco ALT screens.

**The difference is that 5 minutes after surfacing from the dive, operation will now enter Violation Gauge Mode.*

- Down arrow and DOWN message continues to flash until descending below the required Stop Depth, then the full stop graphic will be on solid.
- If the DV1 status is ignored, the i450T will enter DV1 Surface mode for 5 minutes upon surfacing from the dive. Down arrows and Deco Stop depth/time will alternate with SURF TIME. After 5 minutes on the surface in DV1 mode, the unit will enter VGM (Violation Gauge Mode).

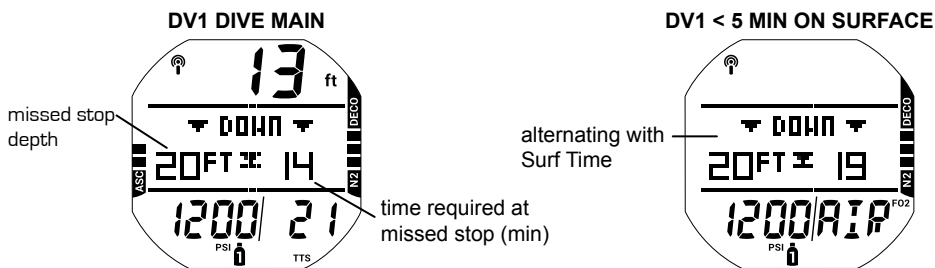

DELAYED VIOLATION 2 (DV 2)

If the calculated Decompression obligation requires a Stop Depth between 60 ft (18 m) and 70 ft (21 m), operation will enter DV2.

The audible alarm will sound and the alarm LED will flash. The full N2 Bar Graph will flash until the audible is silenced.

- Up arrows flash if 10 ft (3 m) deeper than the required Stop Depth.
- Once within 10 ft (3 m) of and below the required Stop Depth, the DECO STOP message and full stop graphic (opposing arrows with stop bar) will be displayed solid.

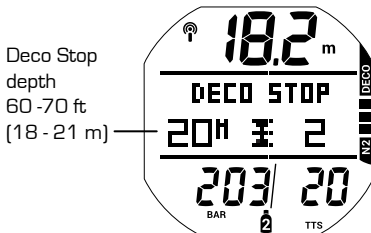

DELAYED VIOLATION 3 (DV 3)

If you descend deeper than the maximum functional depth*, the audible alarm will sound and the alarm LED will flash. Also, the up arrows, and TOO DEEP UP message will flash. Additionally, Current Depth will only indicate dashes signifying that you are too deep.

*The maximum functional depth (Dive/Free = 330 ft / 100 m, Gauge 400 ft/120 m) is the depth at which the i450T can properly perform calculations or provide accurate display information.

Upon ascending above the maximum functional depth, current depth will be restored. However, the log for that dive will display dashes for max depth.

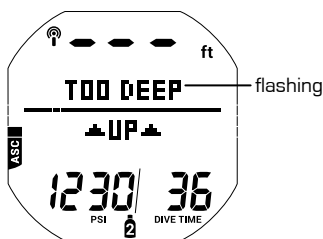

VIOLATION GAUGE MODE (VGM) DURING A DIVE

During Dive mode dives, operation will enter VGM when Deco requires a Stop Depth greater than 70 ft (21 m). It will also enter VGM if Deco is activated during a dive in Free mode, described later. Operation would then continue in VGM during the remainder of that dive and for 24 hours after surfacing. VGM turns the i450T into a digital instrument without any decompression or oxygen related calculations or displays. Upon activation of VGM, the audible alarm will sound and the alarm LED will flash. The message VIOLATION UP with up arrows will flash. After the audible alarm becomes silent (10 seconds), the NO DEC (No Decompression) and N2 Bar Graph will not display for the rest of the dive. GTR (Gas Time Remaining) will be moved to an ALT screen.

VGM DURING AUDIBLE

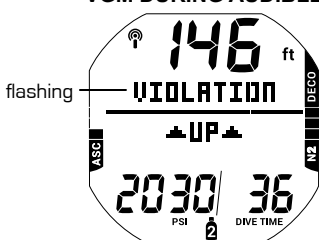

VGM AFTER AUDIBLE

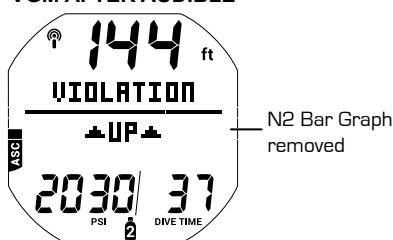

VIOLATION GAUGE MODE (VGM) ON THE SURFACE

The message VIOL (violation) is displayed until 24 hours elapse with no dives. During that 24 hours, VGM lockout does not allow access to the Set Gas, Plan, Desat, and Free mode features/screens. All Watch and Compass functions will be allowed.

- The Fly countdown timer provides the time remaining before normal operation can resume with full features and functions.
- In the event that a dive is made during the 24 hour lockout period, a full 24 hour surface interval must then be served before all functions are restored.

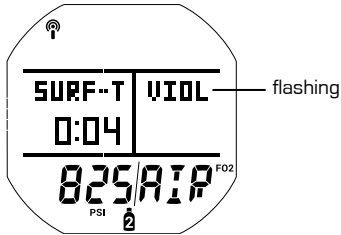

HIGH PO₂

Warning >> at Alarm Set Point value minus .20

Alarm >> at Set Point value, except in Deco then at 1.60 only

Warning

When PO₂ (partial pressure of oxygen) increases to the Warning level; the audible alarm sounds and the PO₂ value will flash (in place of gas pressure) until the audible alarm is silenced.

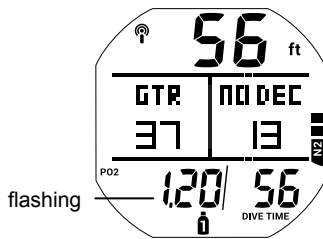

Alarm

If PO₂ continues to increase and reaches the alarm set point, the audible alarm sounds again. The PO₂ value will flash in place of gas pressure during the audible alarm. After the audible alarm is silenced, the PO₂ will alternate with gas pressure. Additionally, the UP message and up arrows will flash continually until PO₂ decreases below the alarm set point.

DURING AUDIBLE ALARM

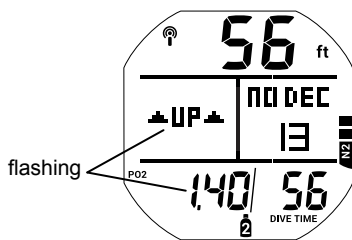

AFTER AUDIBLE ALARM

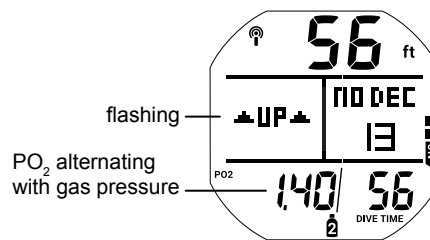

PO₂ During Decompression

The PO₂ alarm setting does not apply when in Decompression. If PO₂ reaches 1.60 while at a Decompression Stop, the PO₂ value (1.60) with icon will flash during the audible alarm. After the audible alarm is silenced, the gas pressure and PO₂ value will alternate until the PO₂ value decreases below 1.60.

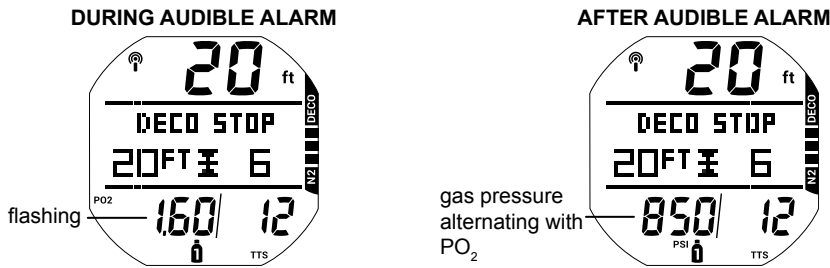

HIGH O₂ SAT (OXYGEN SATURATION)

Warning >> at 80 to 99% (240 OTU)

Alarm >> at 100% (300 OTU)

Warning

When O₂ reaches the Warning Level, the audible alarm sounds and the O₂ SAT (saturation) value will flash in place of the DTR (Dive Time Remaining). The DTR will be restored when the audible alarm is silenced.

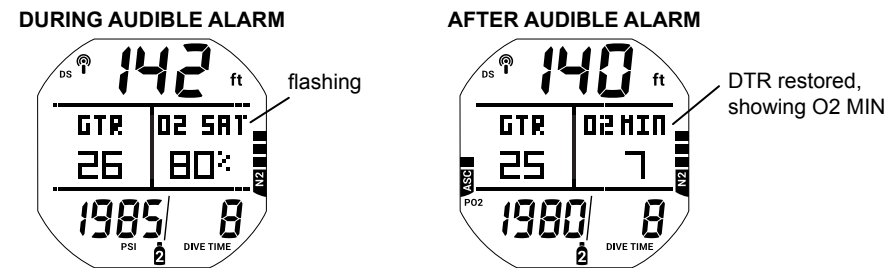

Alarm

If O₂ SAT reaches the Alarm level, the audible alarm sounds. At the same time, the UP message, up arrows, and the O₂ SAT value will flash in place of DTR until surfacing.

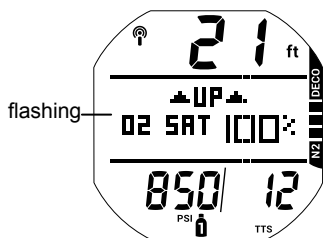

Warning During Decompression

When O₂ SAT reaches the Warning Level, the audible alarm sounds and the O₂ SAT value will flash in the middle of the screen. When the audible alarm is silenced, the standard Deco Dive screen is restored.

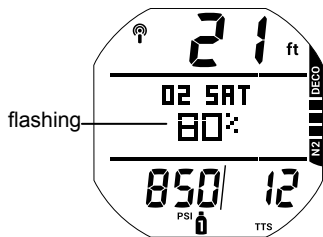

Alarm During Deco

If O2 SAT reaches the Alarm level, the audible alarm sounds and the O2 SAT value will flash in the middle of the screen. When the audible alarm is silenced, Stop Depth and Stop Time alternate with the message O2 SAT 100% until on the surface.

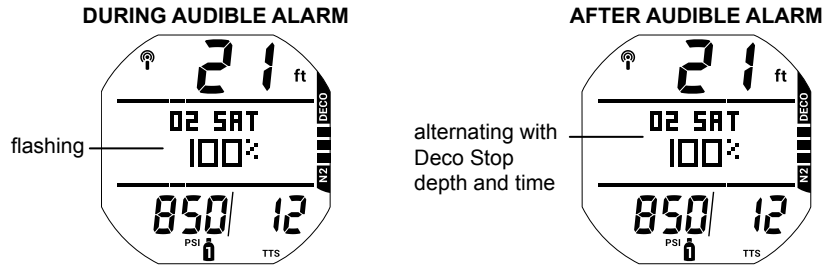

Alarm On Surface

- If O2 SAT is 100% upon surfacing while in No Deco, O2 SAT 100% will flash until the O2 SAT value decreases below 100%.
- If O2 SAT is 100% upon surfacing while still in Deco, SURF-T and O2 SAT will alternate with the missed Deco Stop depth and time until 5 minutes elapse. Then operation will revert to Violation Gauge Mode.

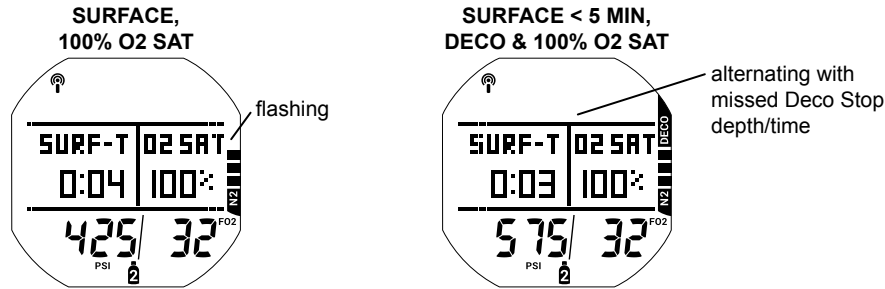

GAUGE MODE

ON THE SURFACE BEFORE A DIVE

There are two Gauge Surface Main screens. The first screen displays before any dives are made. The second screen displays only after a dive.

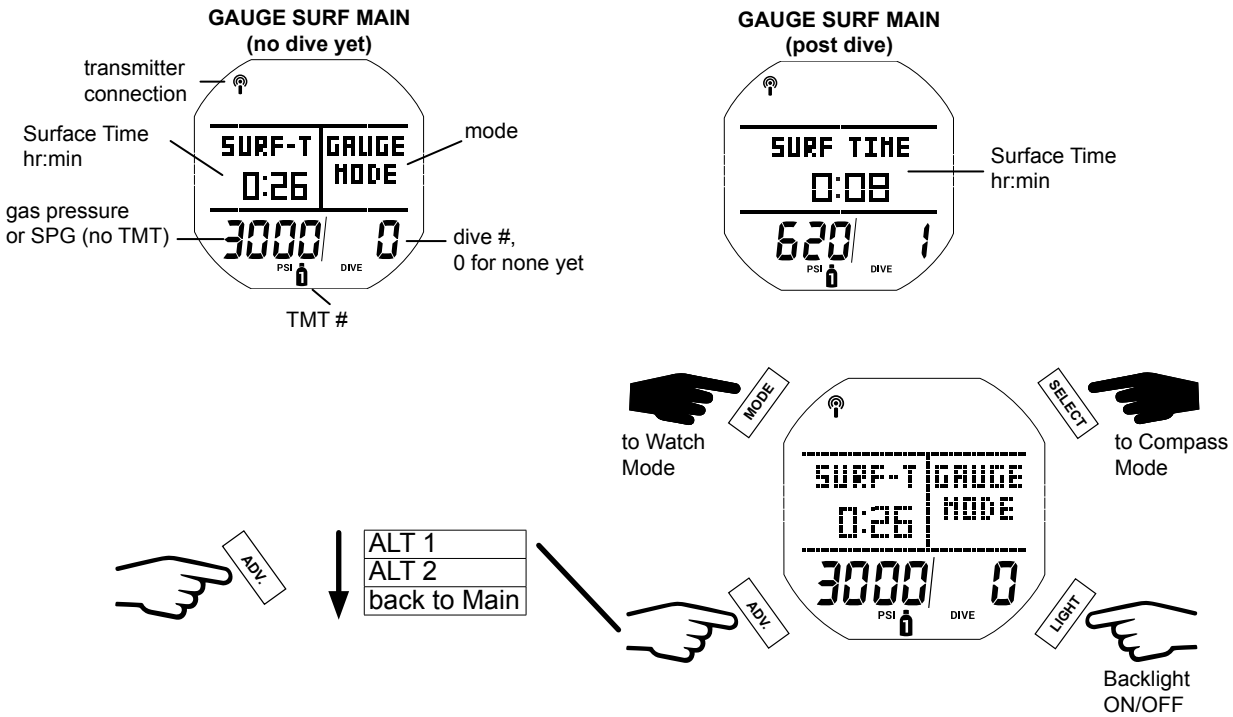

GAUGE SURF MAIN MENU

To view i450T logs, change settings, or switch modes you must navigate through the Surf Main Menu. Enter the menu by pressing the MODE button. Some screens simply display data. While other screens are lead-ins to sub menus and settings. Press the SELECT button to choose menus or options from the Main Menu when available.

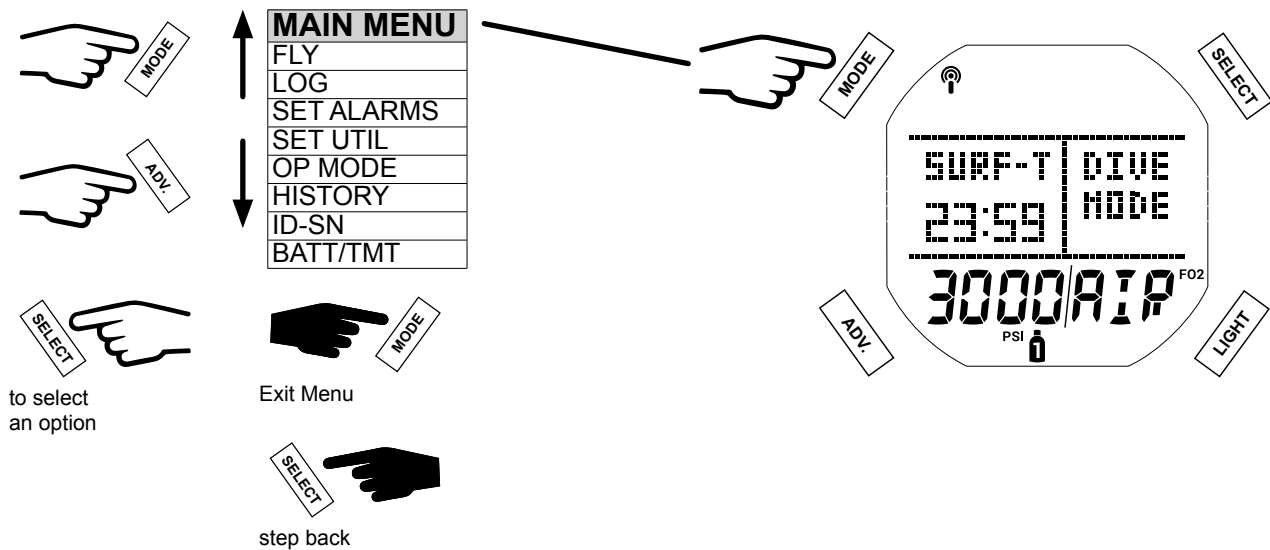

NOTE: Gauge Surface ALT screens and Menu options are similar to those described previously for Dive Mode. See the Dive Surface Mode chapter for further details. Features unique to Gauge Mode are described in the following sections.

RUN TIMER

The Gauge Mode Set Utilities Menu includes an item that allows a Run Timer to be added to the Gauge Dive Main screen.

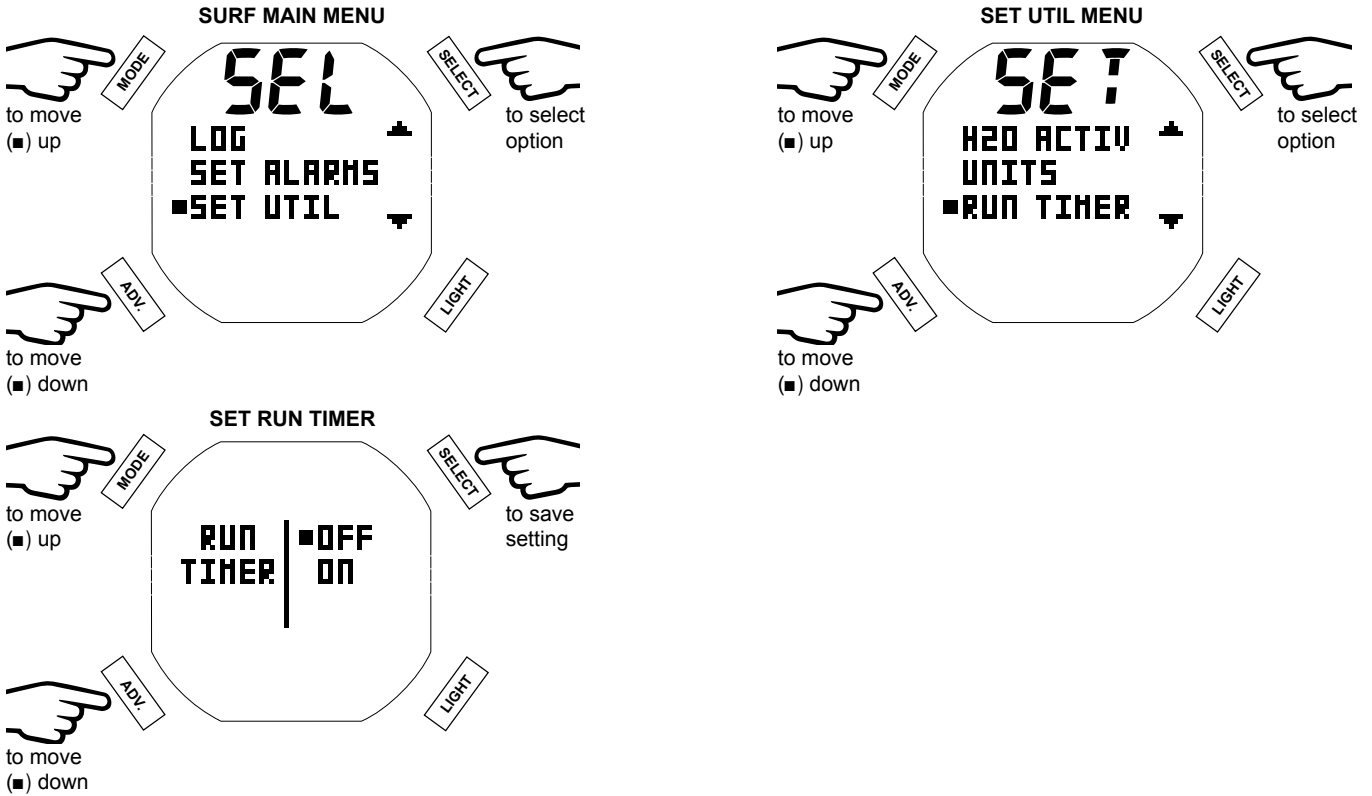

INITIATING A DIVE

With the i450T in Gauge Mode, a dive will commence upon descending to 5 ft (1.5 m) for longer than 5 seconds. Below is a diagram to help you navigate Gauge Dive Mode functions. The dive will end and revert to Surface Mode upon ascent to 3 ft (0.9 m) of depth for at least 1 second.

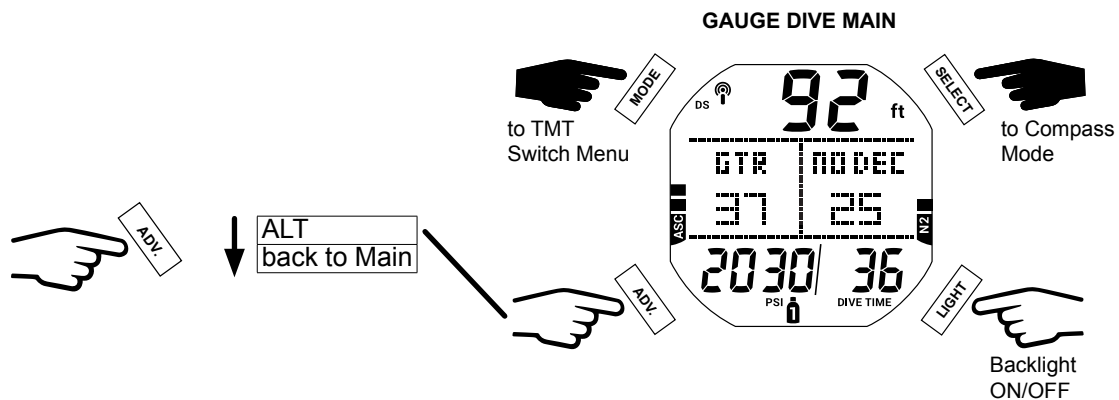

GAUGE DIVE MAIN

The Gauge Dive Main provides basic information including depth, dive time, and ascent rate during the dive.

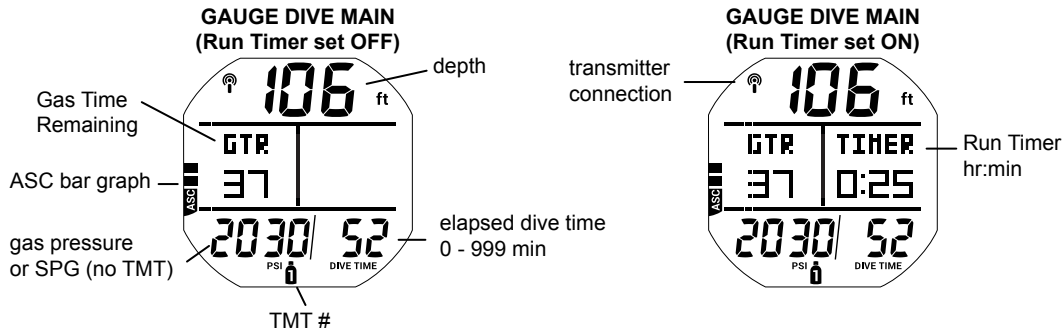

GAUGE DIVE ALT

This screen simply tells you the max depth, current time of day, and ambient temperature.

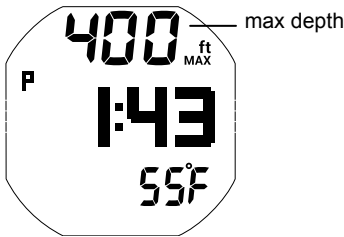

DELAYED VIOLATION 3 (DV3)

If you descend deeper than the maximum functional depth*, the audible alarm will sound and the alarm LED will flash. At the same time, the UP message with up arrows will flash and depth will only indicate dashes signifying that you are too deep. The max depth on the Alt screen will also be represented by dashes.

*The maximum functional depth (Dive/Free = 330 ft / 100 m, Gauge 400 ft/120 m) is the depth at which the i450T can properly perform calculations or provide accurate display information.

Upon ascending above the maximum functional depth, current depth will be restored, however, max depth will continue to be displayed as dashes for the remainder of that dive. The Log for that dive will also display dashes for max depth.

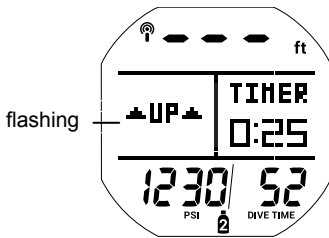

FREE MODE

FREE DIVE MODE DETAILS

- Although breathing apparatus is not utilized for free dive activities, nitrogen tissue loading remains a factor. Nitrogen loading is calculated based upon a fixed FO₂ of Air.
- Since a user has the option of alternating between SCUBA and free dive activities within a 24 hour period, nitrogen calculations and the displayed value of No Decompression Dive Time Remaining are carried over from one operating mode to the other, which permits the user to maintain awareness of nitrogen absorption and off-gassing status.
- The mathematical models currently used in the i450T are based on no decompression/decompression multilevel repetitive dive schedules.
- These algorithms do not take into account the physiological changes associated with the high pressures that competitive type free diving can expose a diver to.

WARNINGS:

- **Ensure that you know which operating mode is selected (DIVE, GAUGE, or FREE) prior to commencing any dive.**
- **Conducting Free dives within a 24 hour period after conducting SCUBA dives, combined with the effects of multiple rapid free dive ascents, increases your risk of decompression sickness. Such activities may result in accelerated entry into decompression which could cause serious injury or death.**
- **Combining competitive type free dive activities that involve multiple descents/ascents with activities utilizing SCUBA during the same 24 hour period is not recommended. Presently, there is no data relating to such activities.**
- **It is highly recommended that anyone planning to become involved in competitive type free dive activities obtain proper instruction and training from a recognized free diving trainer. It is imperative that the physiological affects be understood and the diver is physically prepared.**

ON THE SURFACE BEFORE A DIVE

There are two Free Surface Main screens. The first screen displays when no dives have been made. The second screen displays only after a dive.

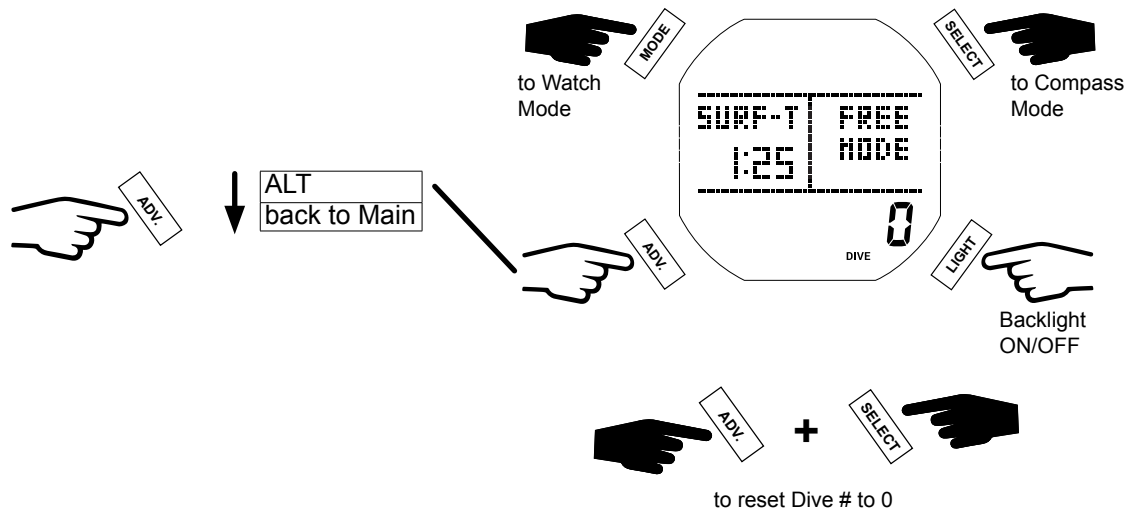
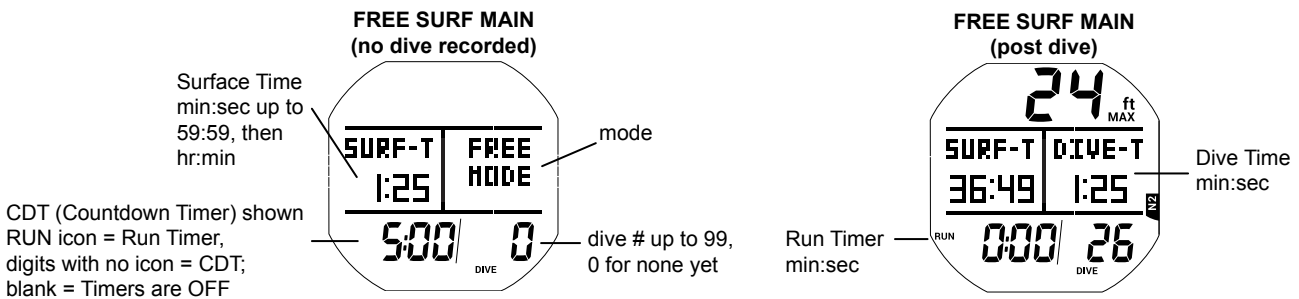

NOTE: The Free ALT screen is similar to the Dive Surface ALT 2 screen described previously. See the Dive Surface Mode chapter for further details.

FREE SURF MAIN MENU

To view i450T Free Dive Logs, change settings, or switch modes you must navigate through the Surf Main Menu. Enter the menu by pressing the MODE button. Some screens simply display data while other screens are lead-ins to sub menus and settings. Press the SELECT button to choose menus or options from the Main Menu when available. All Main Menu screens and options will be discussed in the order they appear in the menu below.

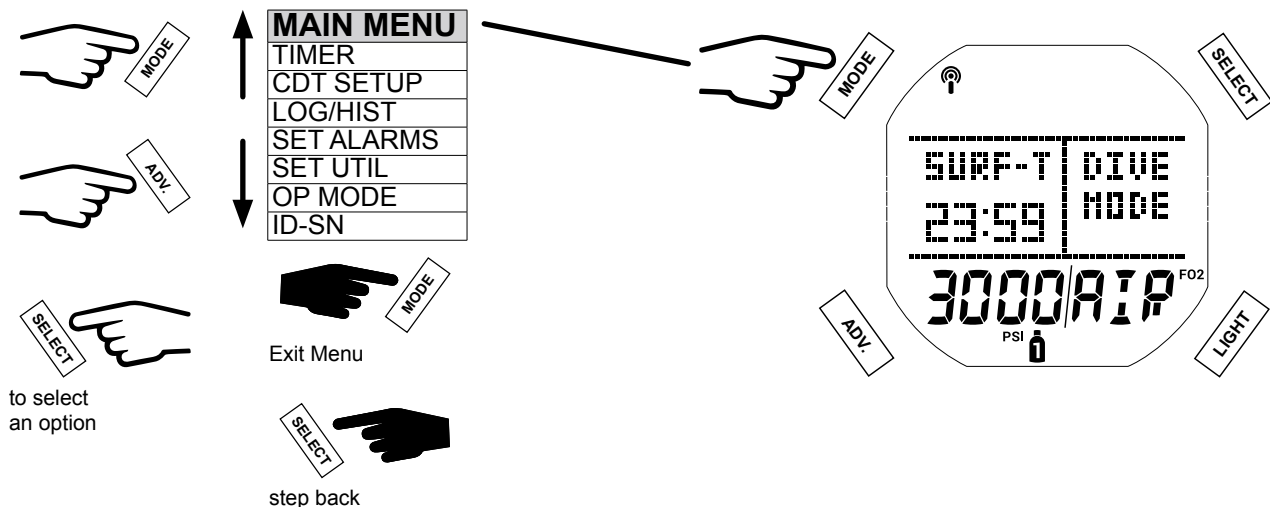

TIMER

The i450T Free Mode has both a programmable CDT (Countdown) and Run timer. The diver may choose to use either of the timers or simply turn them off.

NOTE: Selecting a timer only makes it available on the Main screen. While on the Main screen, the SELECT button must be used to start and stop the selected timer.

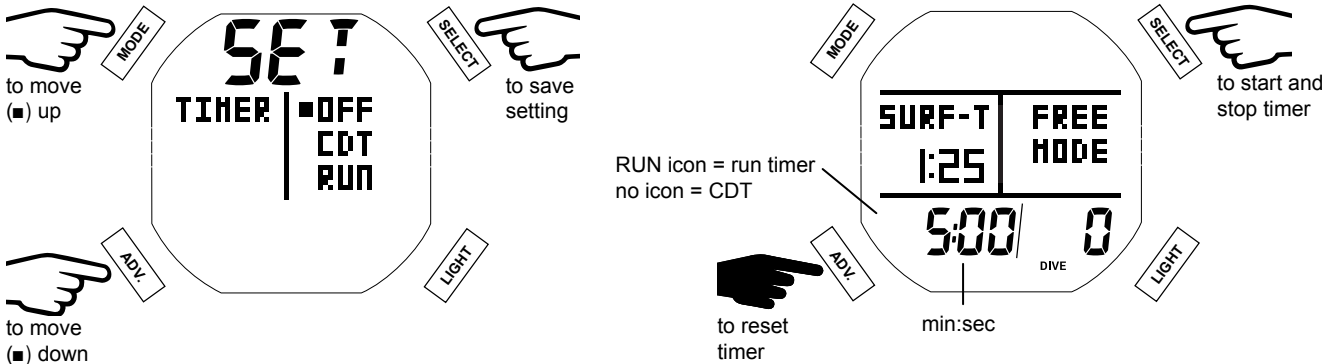

COUNTDOWN TIMER (CDT) SETUP

This screen allows you to set the CDT time from 0:01 - 9:59 (min:sec).

NOTE: Setting the CDT does not start the countdown. While on the Main screen, the SELECT button is used to start and stop the selected timer.

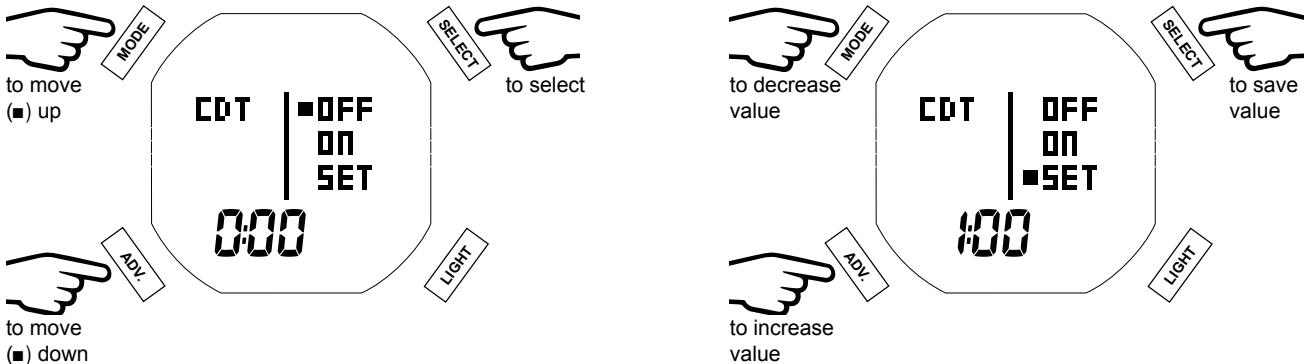

LOG/HIST (HISTORY)

This submenu allows access to Day Log, Full Log, Day History, and Full History.

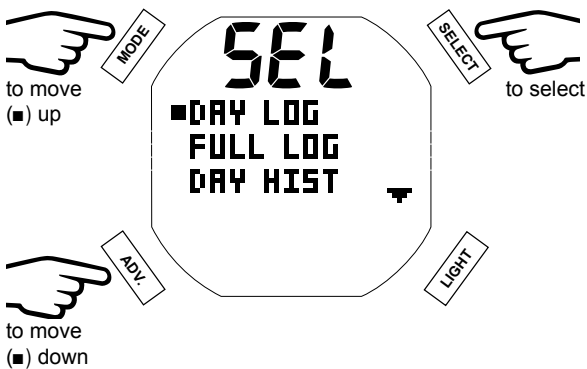

Day Log

Day Log is only retained until a dive is conducted on a new calendar day (at midnight), or the dive # is reset to #1 (by holding ADV. + SELECT buttons while viewing the SURF Main screen) at which time all data is deleted from the Day Log.

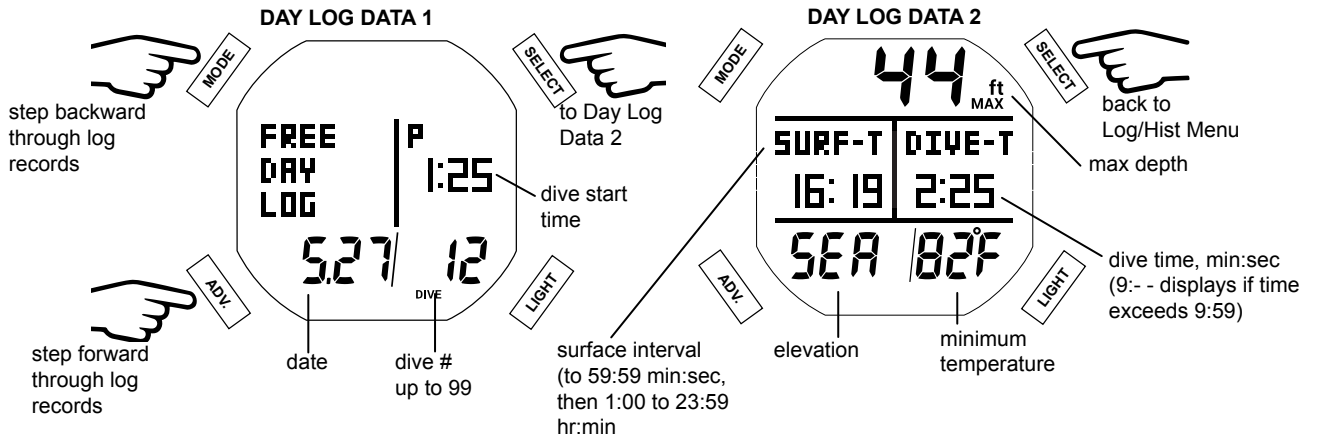

Full Log

The Full Log looks and functions similar to the Day Log but retains all dives until it is eventually overwritten due to storage capacity.

NOTE: After exceeding 99 dives, the most recent Dive will be recorded in the Full Log while deleting the oldest. It is highly unlikely that this will affect the Day Log which will do the same if 99 is exceeded.

Day Hist (History)

Day History records information accumulated during the most recent day.

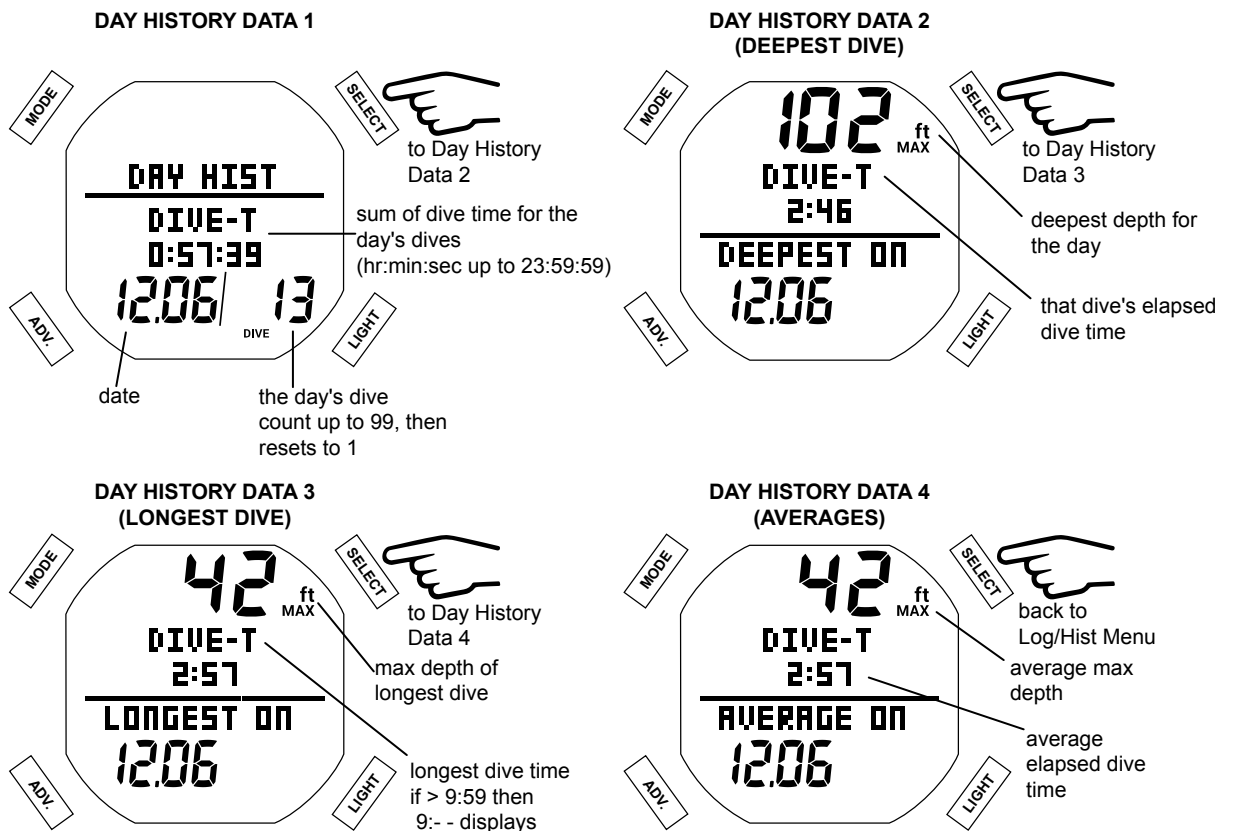

Full Hist (History)

The Full History looks and functions similar to the Day History but records information for all free dives ever made with your i450T.

SET ALARMS

Within this menu you can customize the following seven different alarm settings.



1. AUD (Audible) Alarm

The Audible Alarm feature allows you to set audible alarms ON or OFF.

NOTE: Setting the Audible Alarm OFF disables sounding during all alerts while operating in Free Mode. It does not affect any alarms that are triggered while operating in Dive or Gauge Modes.

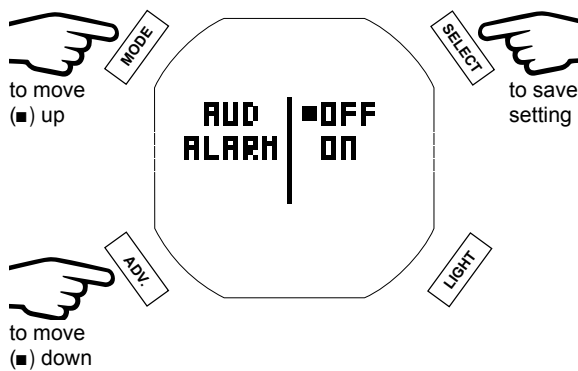

2. SRT (Surface Recovery Time) Alarm

The SRT Alarm allows you to set an alarm for a designated amount of time after surfacing from a dive.

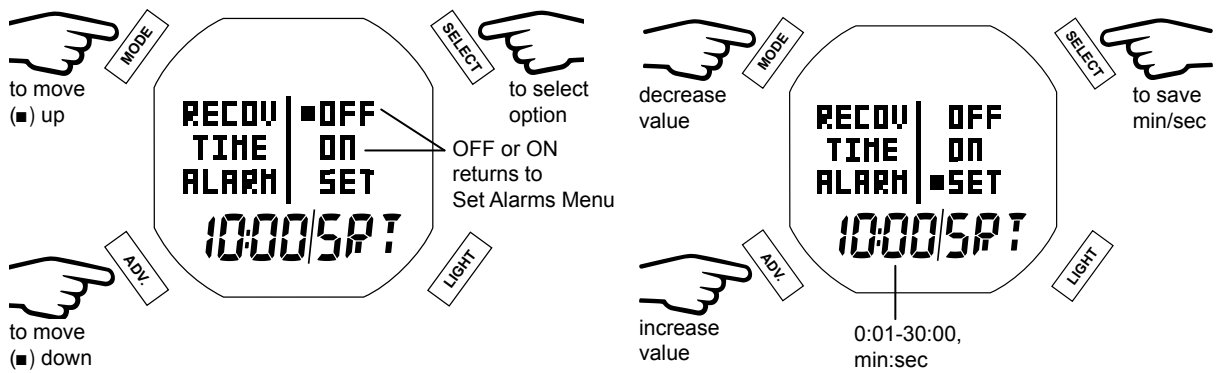

FREE SURF MAIN
(during SRT Alarm)

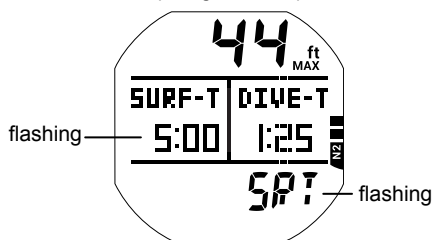

3. RTI (Repeating Time Interval) Alarm

The RTI Alarm allows you to set an alarm to go off repeatedly during a dive at a selected time interval, 0:10-9:59 (min:sec).

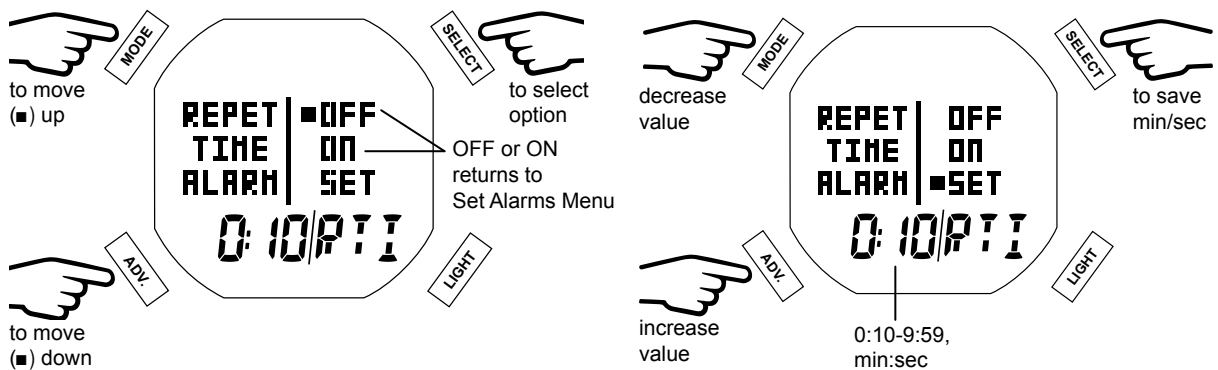

FREE DIVE MAIN
(during RTI Alarm)

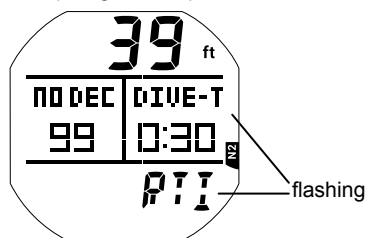

4. RDI (Repeating Depth Interval) Alarm

Unless set to OFF, the RDI Alarm automatically repeats each time the diver descends another increment of depth equal to the set depth interval. The intervals available are 10 - 100 ft (3.0-33.0 m) in 1 ft (1.0 m) increments.

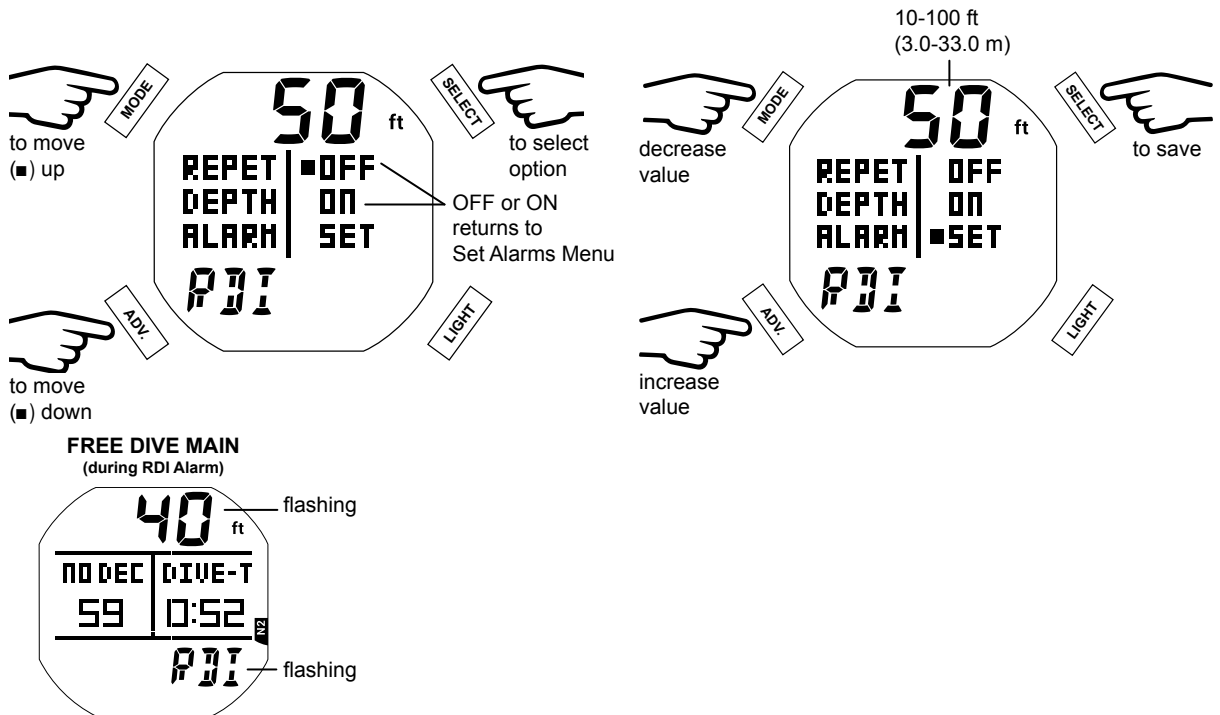

5. DA 1-3 AL (Depth Alarm 1-3)

There are 3 Free DA's (Depth Alarms) that can be set at progressively deeper depths, in intervals of 10 ft (1 m).

NOTE: Each successive DA can only be set deeper than the DA that precedes it. For example: if DA 1 is set for 100 ft then DA 2 settings start at 110 ft.

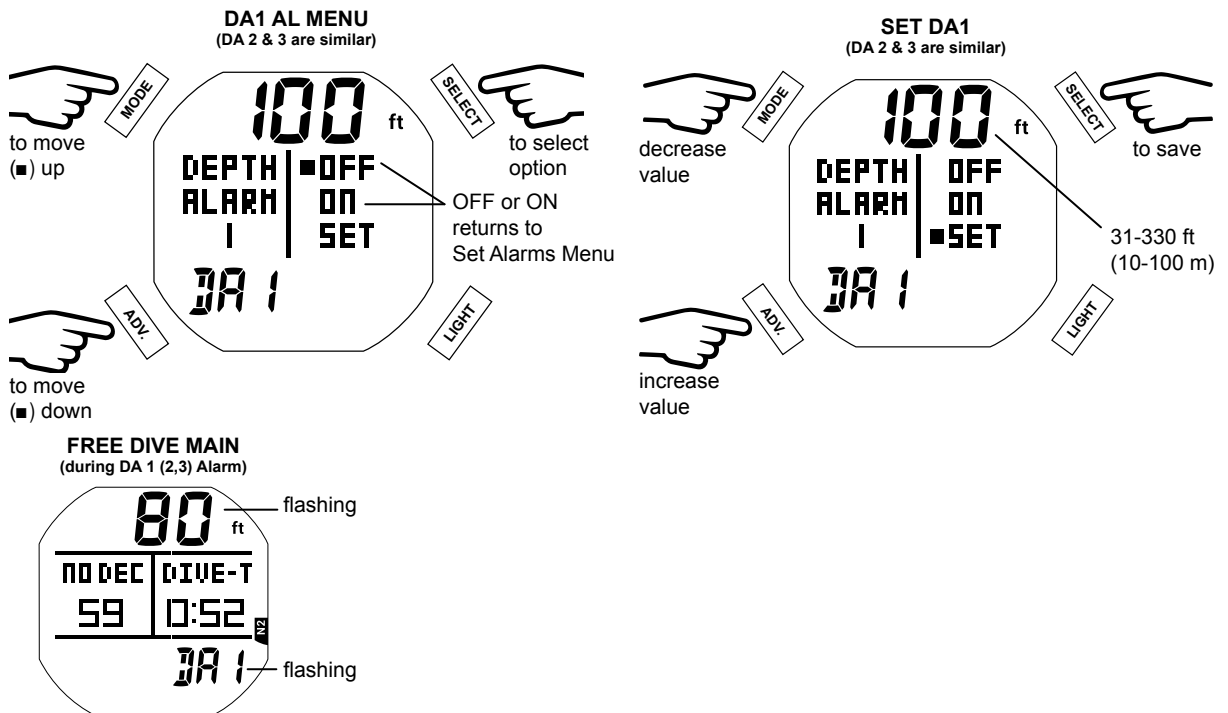

SET UTIL (UTILITY)

Within the Set Util menu you can customize six operational functions.

NOTE: Free Util Menu options are similar to those described previously for Dive Mode. See the Dive Surface Mode chapter for further details. Features unique to Free Mode described below.

1. DSD (Dive Start Depth)

DSD allows you to choose what depth the i450T initiates a dive. You may choose 2, 4, or 6 ft (0.6, 1.2, 1.8 m).

NOTE: Regardless of the Dive Start Depth setting, every dive reverts to the Surface Main screen when an ascent is made above 3 FT (0.9 M) for 1 second.

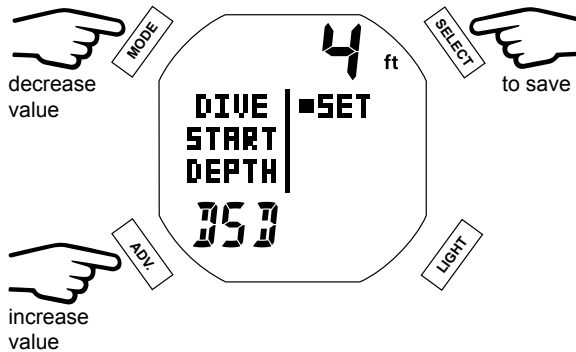

2. DSI (Dive Surface Interval)

The intent of the DSI feature is to allow the user to select the Surface Interval time that is to elapse after surfacing from a dive and prior to start of a new dive.

NOTE: You must wait for the DSI time to elapse before descending for a new repetitive dive. Otherwise, a new repetitive dive will not register and the previous dive is continued.

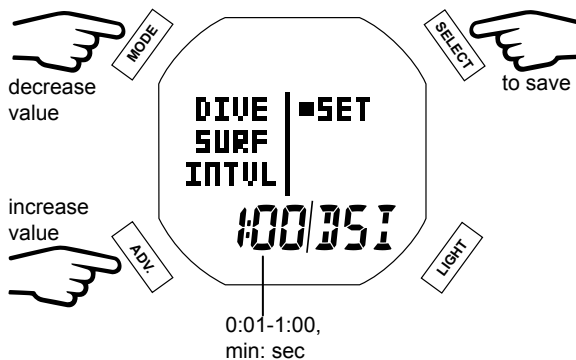

OP (OPERATION) MODE

This feature functions the same as in Dive Mode, see pg. 38.

ID-SN

This feature functions the same as in Dive Mode, see pg. 39.

INITIATING A DIVE

With the i450T in Free Mode, a dive will commence upon descending to the programmed DSD (Dive Start Depth, p.65) for longer than 5 seconds. Below is a diagram to help you navigate Free Dive Mode functions.

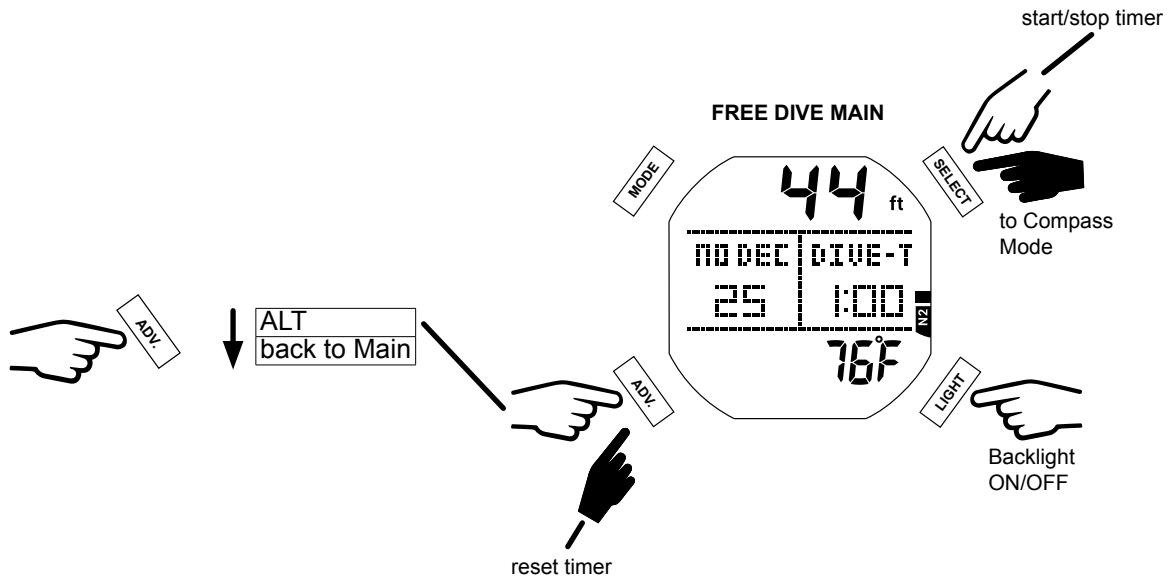

FREE DIVE MAIN

The Free Dive Main provides basic information including depth, no deco time, dive time, temperature and nitrogen loading during the dive.

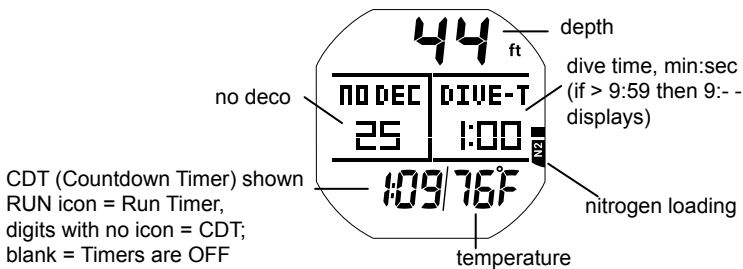

FREE DIVE ALT

This screen simply tells you the max depth and current time of day.

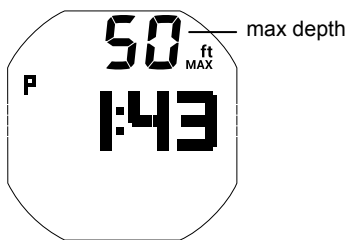

HIGH NITROGEN ALARMS

When nitrogen increases to the caution level (4 N2 Bar Graph segments), the audible alarm will sound 3 sets of 3 beeps. During this time the N2 Bar Graph segments will flash on the Free Dive Main screen.

If nitrogen continues to increase to the Deco level (all 5 N2 Bar Graph segments), the audible alarm will sound again. At this time the N2 Bar Graph segments will flash, and NO DEC (no deco) time will be displayed as 0 min.

When the audible alarm is silenced, the N2 Bar Graph, NO DEC (no deco), and DIVE-T (dive time) values are removed. They are replaced by the message VIOLATION and UP with Up Arrows flashing until on the surface.

After 1 minute on the surface, the graphic VIOL alternates with FREE MODE and dive computer operation locks into Free Mode for 24 hours. Access to Watch Mode and Compass Mode will be as usual.

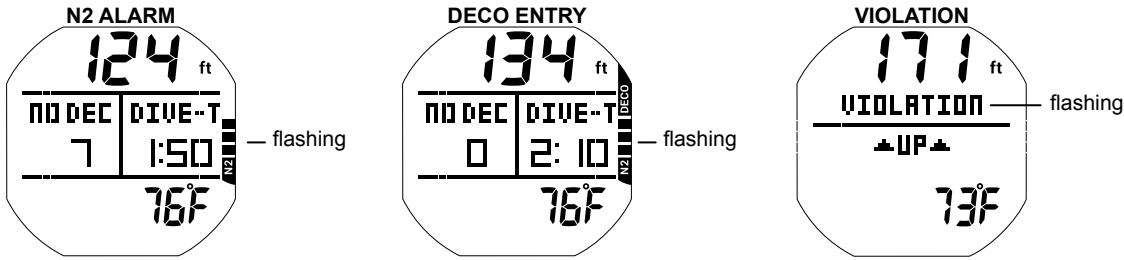

COMPASS MODE

COMPASS DISPLAY ICONS

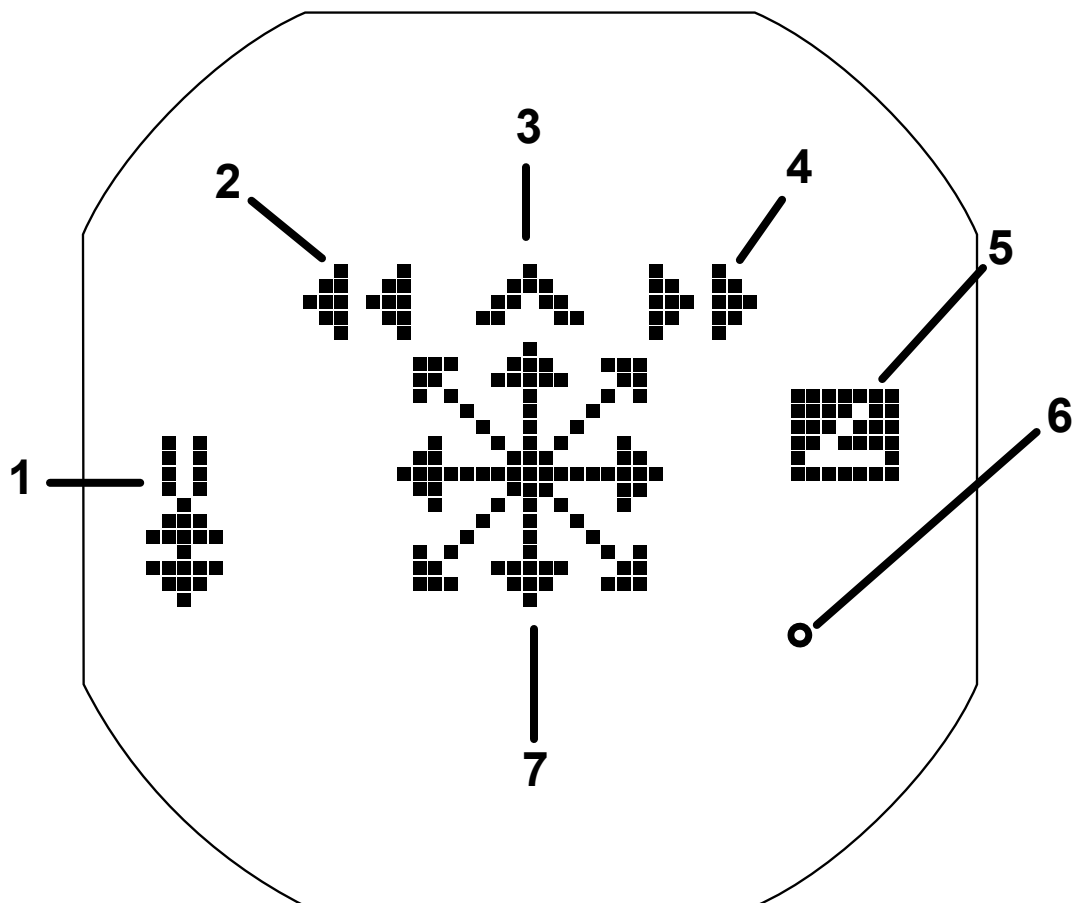

1	Reference Mode
2	Turn Left
3	Diver's Direction (lubber line)
4	Turn Right
5	Tilt ($\geq 20^\circ$ off level)
6	Heading Degrees
7	Dynamic North or Heading Set

OVERVIEW

The i450T is equipped with an advanced digital compass. Compass Mode can be activated while in any other operation mode by holding the SELECT button for at least 2 seconds.

- The i450T reverts back to the previous operation mode after 1 minute unless the Compass Mode is reset by pressing any of the buttons. See the Timeout section at the end of this chapter for further details.
- The compass has both a Stand (Standard) and Ref (Reference) Mode.
- The compass is inaccurate when held $\geq 20^\circ$ off of level. When this occurs the Tilt icon (see previous page) is displayed and the current degree heading is temporarily removed from the display until the i450T is again level.

⚠ WARNING: You must become thoroughly familiar with setup and operation of the i450T Digital Compass before using it as your primary device for navigation. Failure to do so could result in serious errors relating to activities involving navigation.

COMPASS MAIN MENU

The Main menu allows you to choose a compass mode and to adjust compass accuracy. The different selections will be described in the order they appear in the menu.

📌 NOTE: The Main Menu can only be accessed while on the surface. During a dive the i450T will use the last saved settings when accessing the Compass Mode.

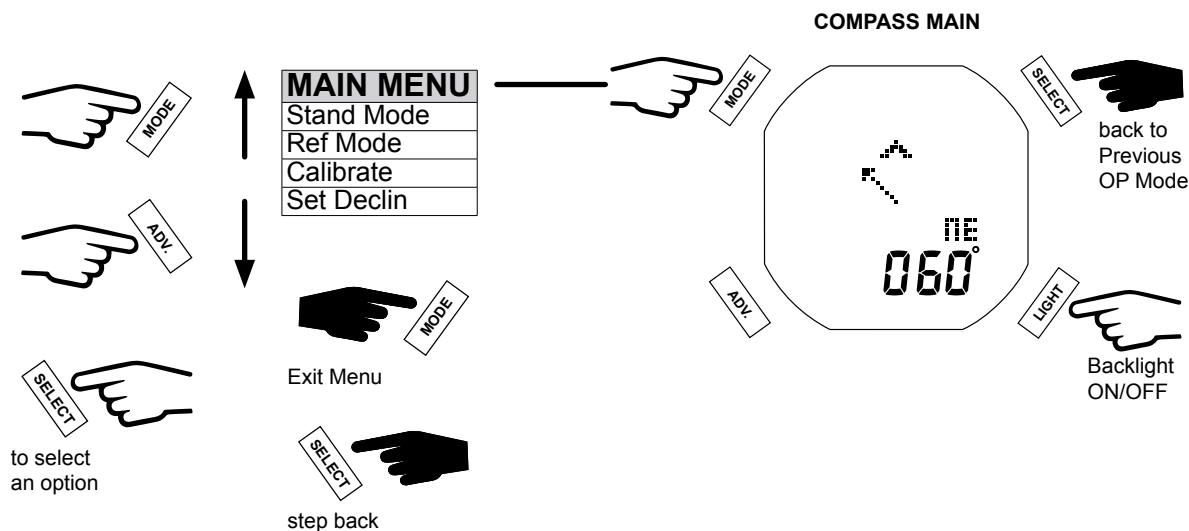

STAND MODE (STANDARD MODE)

In this mode the compass behaves much like an analog compass. The dynamic arrow always points North. The i450T will also give your current heading in both degrees and cardinal/intercardinal direction.

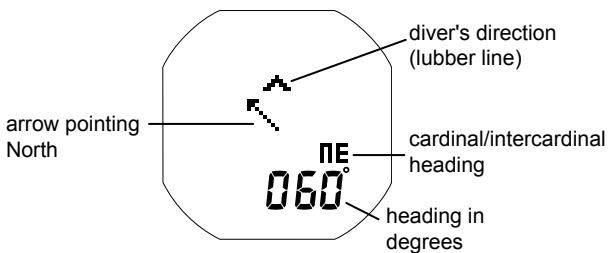

REF MODE (REFERENCE MODE)

Ref Mode allows you to set a course heading or a reverse heading. When the course heading is set the dynamic arrow will point to the selected heading. When off course, correction arrows will indicate which direction to turn to get back on course.

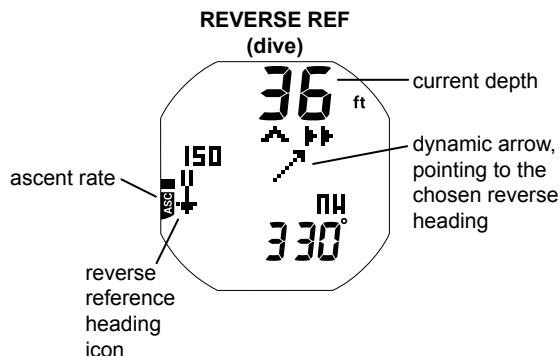
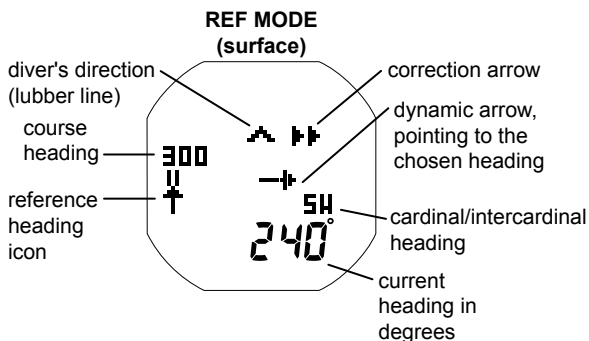

Set Reference Menu

Within this menu you may choose between a reference or reverse reference heading function. The Heading selection will assign the current heading to the direction the compass is pointing. While the Reverse selection will assign the reciprocal heading of the direction the compass is pointing.

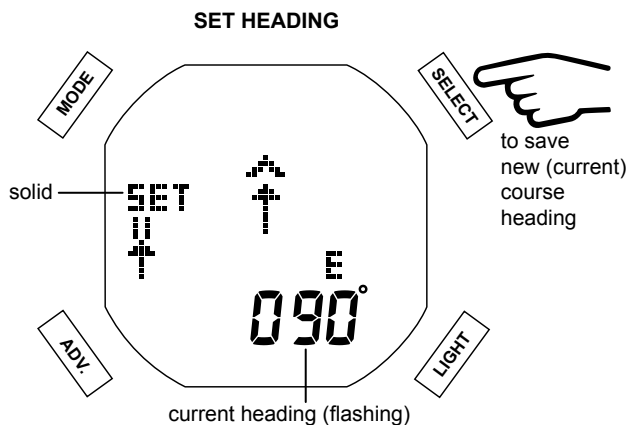
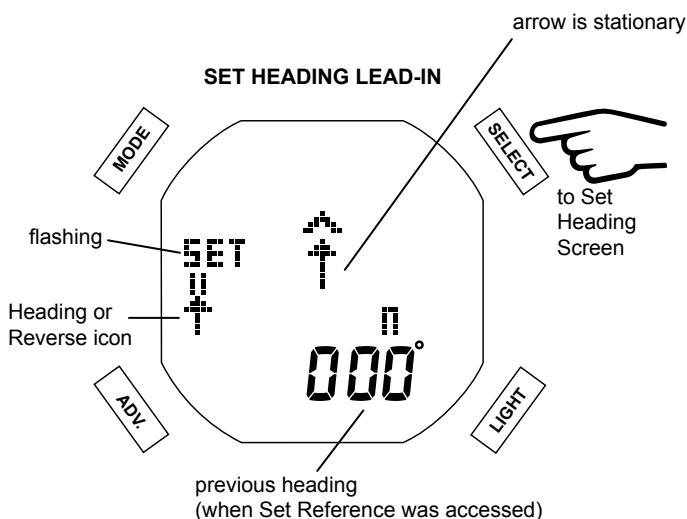
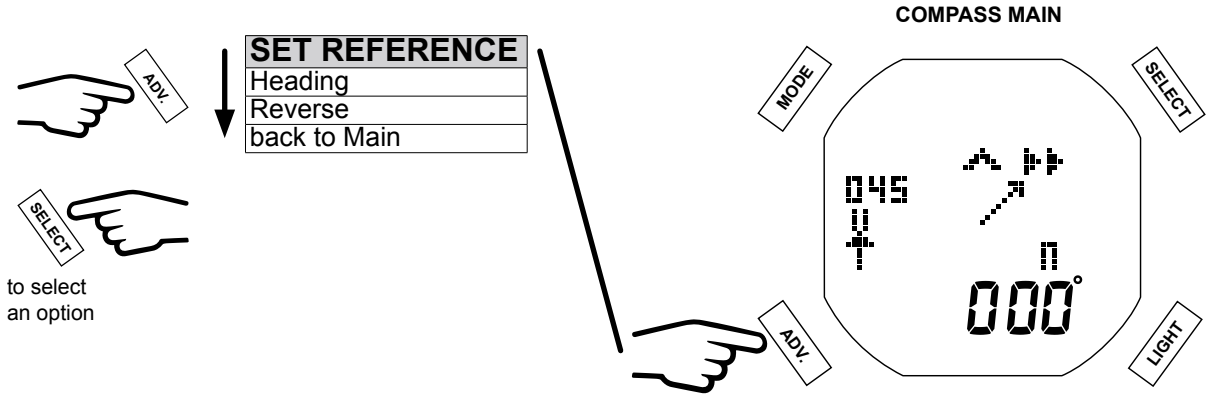

CALIBRATE

You may need to calibrate the compass from time to time to compensate for any magnetic interference (new batteries, new dive location, or other surrounding changes). Sometimes the i450T will prompt for a calibration, after a battery change for example. The Calibration selection in the Compass Main Menu allows you to manually initiate a calibration.

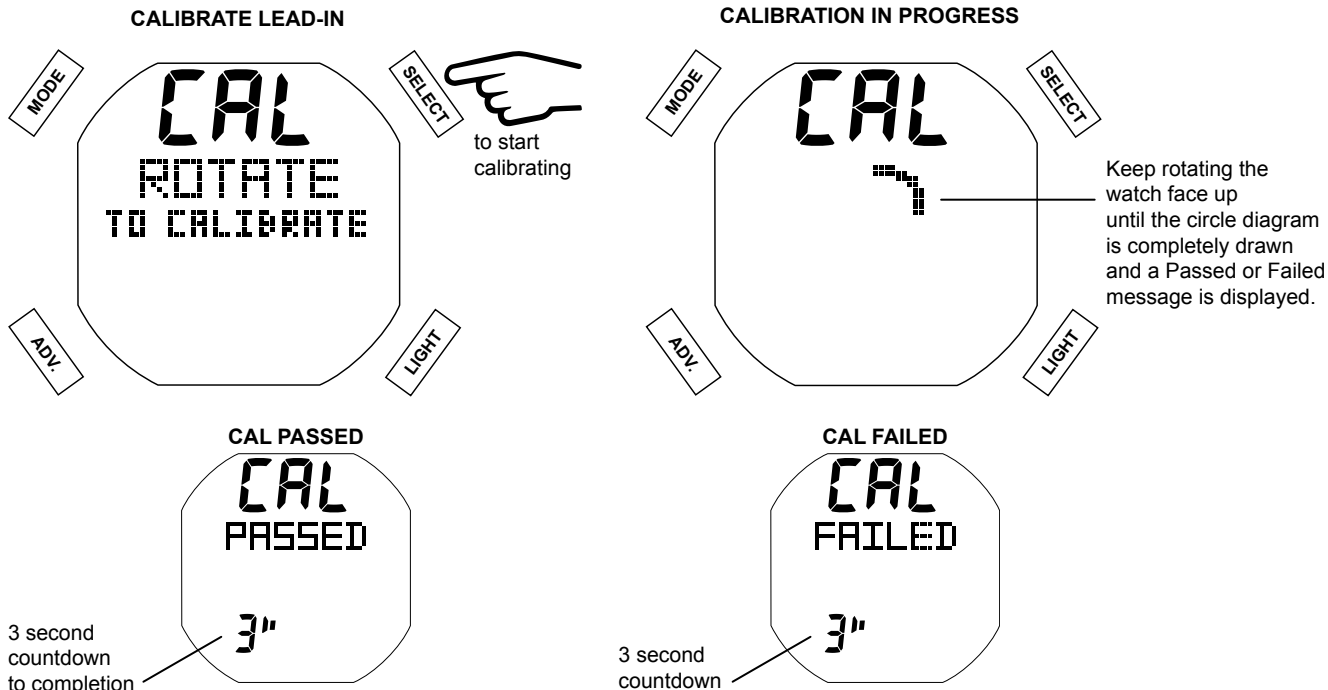

SET DECLIN (DECLINATION)

Magnetic declination or variation measures the angle between the Earth's magnetic north and true north. The declination value for any region can be found on current geographical charts. By correcting for declination, you can achieve a more accurate compass reading.

NOTE: Magnetic north changes over time; so use only current geographical charts to obtain declination value for any geographical region.

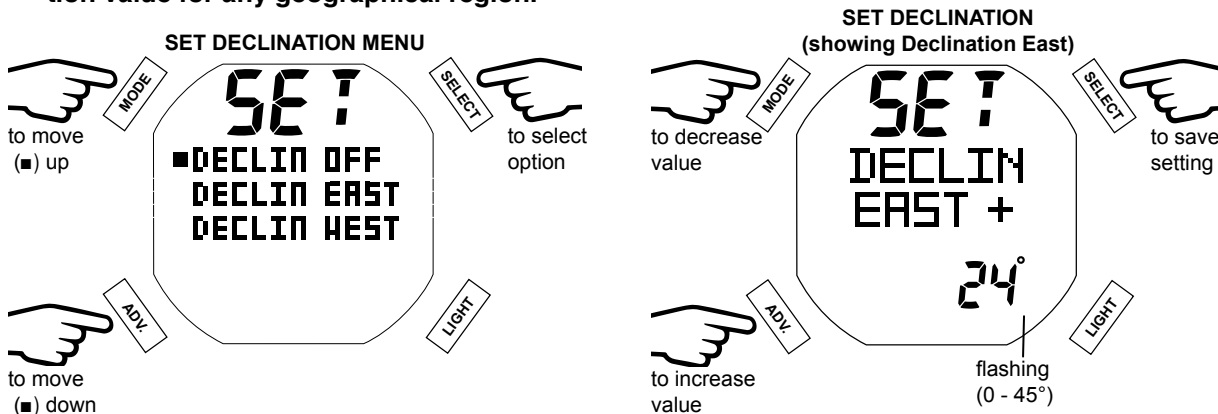

TIMEOUT

The Compass Mode will timeout after 1 minute. There is a 15 second (15") countdown timer displayed before switching back to the previous operation mode. You may reset the timeout at any time by pressing any button on the i450T.

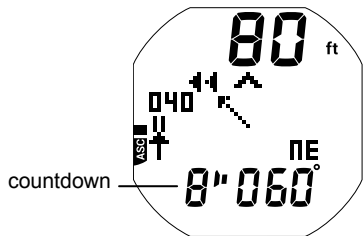

EARMARK

By pressing the Mode button during a dive you can manually record a data snapshot which can later be accessed using the i450T's download feature. The message "EARMARK APPLIED" will be displayed for 3 seconds as confirmation after an earmark is made.



ALARMS

When most alarms are triggered, operation in Compass Mode will be terminated and the Dive Main screen will be displayed describing the alarm condition. Compass Mode can then be reentered by holding SELECT for 2 sec.

The following alarms are those indicated without terminating Compass Mode.

ASC (Ascent) Alarm

When the ascent is faster than the recommended 30 fpm (9 m), all segments flash until the ascent is slowed. See pg. 21 for further details.

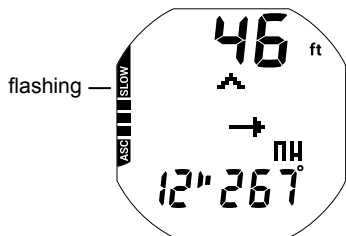

Depth Alarm

Depth digits flash until shallower than the alarm depth set.

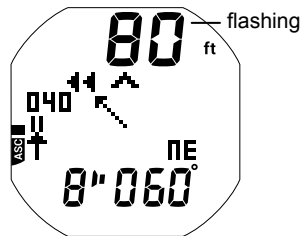

REFERENCE

PC INTERFACE

The Settings Upload portion of the PC Interface (PCI) program can be used to set/change Time, Alarms, and Utilities using the Interface System. The Set Gas group (FO2, PO2 alarms) must be entered using the i450T's button controls.

Information available for retrieval (download) from the i450T to the PC program includes items such as dive number, SI, max depth, EDT, start date/time, start/end pressure, lowest temperature, sampling rate, dive profile, set points, events, and Earmarks. Earmarks are applied to data records during dives then are displayed as indicator symbols on the PC program's graph where notes relating to the experiences at those times can be noted.

Prior to attempting to download data from your i450T or upload settings to it, review the Help section of the download program.

The USB Driver required for the interface system is downloadable from www.aqualung.com. It must be installed on your PC prior to use of the Interface System.

The i450T is configured with a Data Port located on the side that enables it to be connected to a PC USB port using the special Interface Cable.

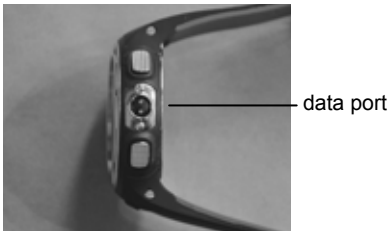

To connect the PCI Cable to the i450T:

- position the connector with the red dot at 12 o'clock.
- align the pins of the cable connector with the holes in the data port and press the connector into the port.
- turn the connector clockwise until the red dot is at 1 o'clock and it locks in, then release it.

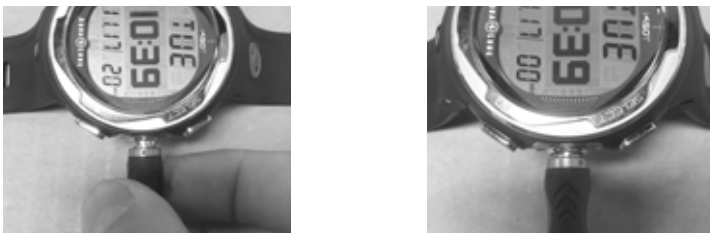

The i450T checks for an external access request every second while Watch Main Time is displayed.

Checks are not to be made if the activation contacts are wet.

For a connection to be made, the download program must be installed on the PC or Mac and open, the associated USB driver must be installed, and the interface cable must be plugged into the PC or Mac USB Port, then connected to the i450T's data port.

When a wakeup connection is established, the graphics PC or MAC COMM and 120 SECONDS will be displayed in place of the Watch Main and remain on the display counting down from 120 to 00 seconds during which time an Upload or Download operation can be initiated.

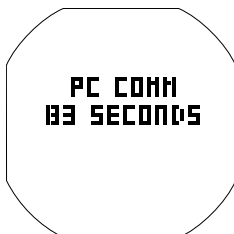

When the operation is initiated using the PC or Mac program, the graphic changes to PC or MAC COMM CONNECTED which remains displayed until completion of the upload/download operation. Then the Watch Main screen is displayed and the cable disconnected.

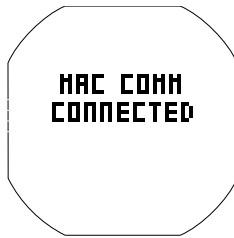

The download software will also accommodate upload of select releases of firmware (operating software) to the i450T using the same PC or Mac interface program and cable. The graphic PROGRAM LOADING is displayed during the process.

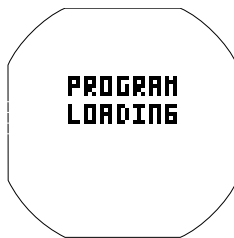

CARE AND CLEANING

Protect your i450T from shock, excessive temperatures, exposure to chemicals, and tampering. Protect the lens against scratches with an Instrument Lens Protector. Small scratches will naturally disappear underwater.

- Soak and rinse the i450T in fresh water at the end of each day of diving, and check to ensure that the areas around the Low Pressure (Depth) Sensor, PC Interface Data Port, and buttons are free of debris or obstructions.
- To dissolve salt crystals, use lukewarm water or a slightly acidic bath (50% white vinegar/50% fresh water). After removal from the bath, place the i450T under gently running fresh water. Towel dry before storing.
- Keep your i450T cool, dry, and protected during transport.



SERVICE

⚠ WARNING: At a minimum, annually check the altitude reading on the ALT 2 screen (p. 14, 26) and Pre-Dive Planner (p. 28) for accuracy. If your i450T is ever out of calibration (incorrect elevation reading, incorrect No Deco Dive Times in the planner, or showing a depth reading at the surface) or displays an error code message (EEP, ALT, CAL, ERR, CSM, A-D), it must be serviced at the factory before use.

If required to return your i450T to the USA factory:

- Obtain an RA (Return Authorization) number by contacting <http://www.aqualung.com/us/support/contact-us> or (760) 597-5000
- Record all dive data in the Log and/or download the data stored in memory. All data will be erased during factory service.

BATTERY REPLACEMENT

- **NOTE:** The procedures that follow must be closely adhered to avoid entrance of water into the unit. Damage due to improper battery replacement (or subsequent leakage of moisture into the unit) is not covered by the i450T's warranty.
- **NOTE:** The i450T can be sent to Aqua Lung, Regional Distributor, or Authorized Dealer Service for proper battery change service which includes pressure (depth) and leak testing to the max operating depth. Standard charges for service will apply.

The battery compartment should be opened only in a dry and clean environment with extreme care taken to prevent the entrance of moisture or dust.

As an additional precautionary measure to prevent formation of moisture in the battery compartment, it is recommended that the battery be changed in an environment equivalent to the local outdoor temperature and humidity (e.g., do not change the battery in an air conditioned environment then take it outside during a hot sunny day).

Inspect the buttons, lens, and housing to ensure they are not cracked or damaged. If there is any sign of moisture in the i450T, **DO NOT** attempt to use it for diving until it receives proper service by the Aqua Lung factory or an authorized regional distributor.

Data Retention

When the battery is removed, settings and nitrogen/oxygen calculations for repetitive dives will be retained in volatile memory until a new battery is installed. You will have the choice of saving or deleting the data. The Compass will need to be calibrated after the new battery is installed.

All parts needed for the battery change that follows are provided in the i450T Battery Kit available from your Aqua Lung Dealer.

Battery Removal

- There is no need to remove the straps.
- Remove the (4) retaining screws located on the back of the case by turning them counterclockwise with a small flat tip 3 mm screw driver.
- Carefully separate the front and back sections. If necessary, insert a small flat tip screw driver in the slot machined into the cover at the 11 o'clock position and gently pry the battery cover loose, then lift it off the case.
- Turn the case to one side to drop the battery into your hand. If necessary, gently loosen it with the tip of your finger. **DO NOT** use tools to pry it out, or short the positive (+) top of the Battery to the negative (-) contact under it.
- Discard the battery according to local regulations governing disposal of lithium batteries.

REMOVE SCREWS



LOOSEN BATTERY COVER



REMOVE BATTERY COVER



REMOVE BATTERY



Inspection

- Closely check all of the sealing surfaces for any signs of damage that might impair proper sealing.
- Inspect the button, lens, and housing to ensure they are not cracked or damaged.

⚠ WARNING: If damage or corrosion is found, return your i450T to an authorized Aqua Lung dealer, and DO NOT attempt to use it until it has received factory prescribed service.

- Remove the cover O-ring by squeezing the sides. Discard, and **DO NOT** attempt to reuse it.

⚠ CAUTION: DO NOT use tools to remove the O-ring. To ensure proper sealing, O-ring replacement is required each time the battery is replaced.

REMOVE O-RING



Battery Installation

⚠ CAUTION: The O-ring must be a genuine Aqua Lung part that can be purchased from an authorized Aqua Lung dealer. Use of any other O-ring will void the warranty.

- Very lightly lubricate the new O-ring with silicone grease and place it on the top rim of the cover.
- Place a new 3 volt type CR2450 lithium battery, negative side down into the battery cavity and ensure that it is evenly positioned.
- Carefully position the battery cover over the battery compartment. Use the i450T logo as a guide for top/bottom.
- While ensuring that the cover and back of the case are properly aligned, firmly press them evenly and completely together.
- While holding the battery cover firmly in position against the back of the case, insert the (4) retaining screws and tighten them until secure by turning them clockwise with a small flat tip 3mm screw driver. **DO NOT** over-tighten.

REPLACE BATTERY



INSTALL COVER



INSTALL SCREWS



Testing

- Activate the unit and ensure that the LCD is clear and sharp in contrast. If any portions are missing or appear dim, or if a low battery condition is indicated, return the i450T to an authorized Aqua Lung dealer for evaluation before use.
- During 24 hours after completion of a dive, the graphics SEL and DATA with selections SAVE ? and CLEAR ? will be displayed giving you the option to retain or delete Ni-O2 calculations for repetitive dives.

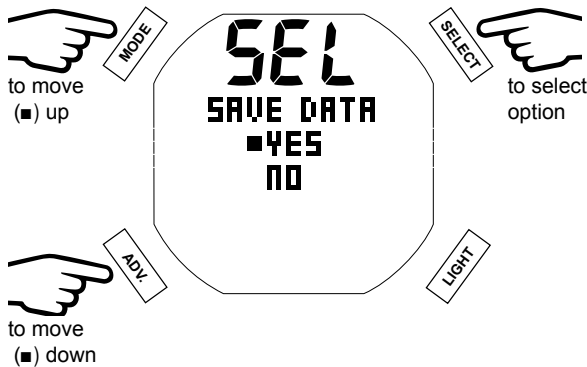

- Graphics DATA SAVED (or CLEARED) with CAL COMPASS appear for 3 seconds, then operation reverts to the Compass CAL screen.



- Calibrate the compass.
- Verify all set points prior to diving.

ALTITUDE SENSING AND ADJUSTMENT

Prior to the first dive of a series of repetitive dives, Altitude (i.e., ambient pressure) is measured upon activation of Dive Surface Mode and every 15 minutes until a dive is made or operation reverts to Watch Mode.

- While it is operating in Watch Mode after a dive, measurements are taken every 15 minutes during the 24 hour period after surfacing.
- Measurements are only taken when the unit is dry.
- Two readings are taken, the second reading 5 seconds after the first. The readings must be within 1 foot (30 cm) of each other to record that ambient pressure as the current altitude.
- No adjustments are made during any time that the wet contacts are bridged.

When diving in high altitude waters from 3,001 to 14,000 feet (916 to 4,270 meters), the i450T automatically adjusts to these conditions providing corrected depth, and reduced No Deco and O2 Times at intervals of 1,000 feet (305 meters).

At an elevation of 3,001 feet (916 meters), Depth calibration automatically changes from feet of seawater to feet of fresh water. This is the first adjustment to the algorithm. When the Conservative Factor feature is set to ON, No Deco Times are calculated based upon the next higher 3,000 foot (915 meter) Altitude. All adjustments for altitudes greater than 11,000 feet (3,355 meters) are then made to allowable dive times for 14,000 feet (4,270 meters). At Sea Level, calculations are based upon an altitude of 6,000 feet.

The i450T will not function as a dive computer above 14,000 feet (4,270 meters).

TECHNICAL DATA

NO DECO TIME LIMITS

PZ+ ALGORITHM >> NDLS (HR:MIN) AT ALTITUDE (IMPERIAL)

Altitude (feet)	0 to 3000	3001 to 4000	4001 to 5000	5001 to 6000	6001 to 7000	7001 to 8000	8001 to 9000	9001 to 10000	10001 to 11000	11001 to 12000	12001 to 13000	13001 to 14000
Depth (FT)												
30	3:17	2:30	2:21	2:14	2:08	2:02	1:57	1:52	1:47	1:39	1:34	1:29
40	1:49	1:21	1:15	1:11	1:08	1:05	1:02	1:00	0:57	0:55	0:53	0:51
50	1:05	0:53	0:51	0:49	0:47	0:44	0:42	0:39	0:37	0:35	0:34	0:33
60	0:48	0:37	0:35	0:33	0:32	0:30	0:28	0:26	0:24	0:23	0:22	0:21
70	0:35	0:26	0:24	0:23	0:21	0:20	0:19	0:18	0:17	0:16	0:16	0:14
80	0:26	0:19	0:18	0:17	0:16	0:15	0:14	0:13	0:12	0:11	0:11	0:10
90	0:19	0:15	0:14	0:13	0:12	0:11	0:10	0:10	0:09	0:09	0:08	0:08
100	0:16	0:11	0:10	0:10	0:09	0:09	0:08	0:08	0:07	0:07	0:07	0:07
110	0:12	0:09	0:08	0:08	0:07	0:07	0:07	0:07	0:06	0:06	0:06	0:05
120	0:10	0:08	0:07	0:07	0:07	0:06	0:06	0:06	0:05	0:05	0:05	0:05
130	0:08	0:07	0:06	0:06	0:06	0:05	0:05	0:05	0:05	0:05	0:04	0:04
140	0:07	0:06	0:05	0:05	0:05	0:05	0:05	0:04	0:04	0:04	0:04	0:04
150	0:06	0:05	0:05	0:05	0:05	0:04	0:04	0:04	0:04	0:04	0:04	0:03
160	0:06	0:05	0:05	0:04	0:04	0:04	0:04	0:04	0:04	0:03	0:03	0:03
170	0:05	0:04	0:04	0:04	0:04	0:04	0:03	0:03	0:03	0:03	0:03	0:03
180	0:05	0:04	0:04	0:04	0:03	0:03	0:03	0:03	0:03	0:03	0:03	0:03
190	0:04	0:04	0:04	0:03	0:03	0:03	0:03	0:03	0:03	0:03	0:03	0:00

PZ+ ALGORITHM >> NDLS (HR:MIN) AT ALTITUDE (METRIC)

Altitude (meters)	0 to 915	916 to 1220	1221 to 1525	1526 to 1830	1831 to 2135	2136 to 2440	2441 to 2745	2746 to 3050	3051 to 3355	3356 to 3660	3661 to 3965	3966 to 4270
Depth (M)												
9	3:37	2:41	2:31	2:23	2:16	2:10	2:04	1:59	1:54	1:50	1:43	1:37
12	1:55	1:27	1:21	1:15	1:12	1:08	1:05	1:03	1:00	0:58	0:55	0:54
15	1:08	0:55	0:53	0:51	0:49	0:47	0:44	0:42	0:39	0:37	0:36	0:34
18	0:50	0:39	0:37	0:35	0:33	0:32	0:30	0:28	0:26	0:24	0:23	0:22
21	0:36	0:28	0:26	0:24	0:23	0:21	0:20	0:19	0:18	0:17	0:16	0:16
24	0:27	0:20	0:19	0:18	0:17	0:16	0:15	0:14	0:13	0:12	0:11	0:11
27	0:20	0:16	0:15	0:13	0:12	0:11	0:11	0:10	0:09	0:09	0:09	0:08
30	0:16	0:12	0:11	0:10	0:09	0:09	0:09	0:08	0:08	0:07	0:07	0:07
33	0:13	0:09	0:09	0:08	0:08	0:07	0:07	0:07	0:07	0:06	0:06	0:06
36	0:10	0:08	0:07	0:07	0:07	0:06	0:06	0:06	0:05	0:05	0:05	0:05
39	0:09	0:07	0:06	0:06	0:06	0:06	0:05	0:05	0:05	0:05	0:05	0:04
42	0:08	0:06	0:06	0:05	0:05	0:05	0:05	0:05	0:04	0:04	0:04	0:04
45	0:06	0:05	0:05	0:05	0:05	0:04	0:04	0:04	0:04	0:04	0:04	0:04
48	0:06	0:05	0:05	0:04	0:04	0:04	0:04	0:04	0:04	0:03	0:03	0:03
51	0:05	0:04	0:04	0:04	0:04	0:04	0:04	0:03	0:03	0:03	0:03	0:03
54	0:05	0:04	0:04	0:04	0:04	0:03	0:03	0:03	0:03	0:03	0:03	0:03
57	0:05	0:04	0:04	0:03	0:03	0:03	0:03	0:03	0:03	0:03	0:03	0:03

ALTITUDE LEVELS

DISPLAY	RANGE: FEET (METERS)
SEA	0 to 3,000 (915)
EL2	3,001 to 5,000 (916 to 1,525)
EL3	5,001 to 7,000 (1,526 to 2,135)
EL4	7,001 to 9,000 (2,136 to 2,745)
EL5	9,001 to 11,000 (2,746 to 3,355)
EL6	11,001 to 13,000 (3,356 to 3,965)
EL7	> 13,000 (3,965)

OXYGEN EXPOSURE LIMITS

(from NOAA Diving Manual)

PO ₂ (ATA)	MAX DURATION SINGLE EXPOSURE (MIN)	MAX TOTAL DURATION 24 HOUR DAY (MIN)
0.60	720	720
0.70	570	570
0.80	450	450
0.90	360	360
1.00	300	300
1.10	240	270
1.20	210	240
1.30	180	210
1.40	150	180
1.50	120	180
1.60	45	150

SPECIFICATIONS

CAN BE USED AS

- Watch
- Dive Computer (Air or Nitrox)
- Digital Depth Gauge/Timer
- Free Dive Computer

DIVE COMPUTER PERFORMANCE

- Bühlmann ZHL-16C based PZ+ algorithm
- Decompression in agreement with Bühlmann ZHL-16C
- No Decompression Deep Stops - Morroni, Bennett
- Decompression Deep Stops (not recommended) - Blatteau, Gerth, Gutvik
- Altitude - Bühlmann, IANTD, RDP (Cross)
- Altitude corrections and O2 limits based on NOAA tables

OPERATIONAL PERFORMANCE

- | | |
|-----------|-------------------|
| Function: | Accuracy: |
| • Depth | ±1% of full scale |
| • Timers | 1 second per day |

Dive Counter:

- DIVE/GAUGE displays Dives #1 to 24, FREE displays #1 to 99 (0 if no dive made)
- Resets to Dive #1, upon diving (after 24 hours with no dives)

Dive Log Mode:

- Stores 24 most recent DIVE/GAUGE dives in memory for viewing
- After 24 dives, adds 25th dive in memory and deletes the oldest dive

Altitude:

- Operational from sea level to 14,000 feet (4,270 meters) elevation
- Measures ambient pressure every 30 minutes when inactive, upon activation, every 15 minutes while activated.
- Does not measure ambient pressure when wet.
- Compensates for Altitudes above sea level beginning at 3,001 feet (916 meters) elevation and every 1,000 feet (305 meters) higher.

Power:

- (1) 3 vdc, CR2450, lithium battery (Panasonic or equivalent)
- Shelf life Up to 7 years (dependent on battery manufacturer)
- User replacement battery (annual recommended)
- Use Life 1 year or 300 dive hours if (qty: 2) 1 hour dives per dive day.

Battery Icon:

- Warning - icon on solid at 2.75 volts, Battery change recommended
- Alarm - icon on flashing at 2.50 volts, change the Battery

Operating Temperature:

- Out of the water - between 20 °F and 140 °F (-6.6 and 60 °C).
- In the water - between 28 °F and 95 °F (-2.2 and 35 °C).

N2 Bar Graph

- No Decompression Normal Zone
- No Decompression Caution Zone
- Decompression Zone

segments

- 1 to 3
- 4
- 5 (all)

ASC (Ascent) Rate

- Normal zone
- Normal zone
- Normal zone
- Normal zone
- Caution zone
- Too Fast zone (flashing)

<u>segments</u>	<u>FPM</u>	<u>MPM</u>
0	0 - 10	0 - 3
1	11 - 15	3.5 - 4.5
2	16 - 20	5 - 6
3	21 - 25	6.5 - 7.5
4	26 - 30	8 - 9
5 (all)	> 30	> 9

NUMERIC DISPLAYS:

- Dive Number
- Depth
- FO₂ Set Point
- PO₂ Value
- Dive Time Remaining
- Time To Surface
- No Decompression Deep Stop Time
- No Decompression Safety Stop Time
- Decompression Stop Time
- DIVE/GAUGE Elapsed Dive Time
- Free Elapsed Dive Time
- Surface Interval Time
- Free Surface Interval Time
- Time to Fly & Desaturate
- Temperature
- Time of Day
- Free Countdown Timer
- Violation Countdown Timer

Range:

- 0 to 24
- 0 to 495 FT (120 M)
(0 - 99.9 M, > 99.9 then 100 -150 M)
- Air, 21 to 100 %
- 0.00 to 5.00 ATA
- 0 to 99 min, display 99 if >99 min
- 0 to 99 min, display - - if >99 min
- 2 to 0 min
- 5 to 0 min
- 0 to 999 min
- 0 to 999 min
- 0:00 to 9:59 min:sec
- 0:00 to 23:59 hr:min
- 0:00 to 59:59 min:sec,
then 1:00 to 23:59 hr:min
- 23:50 to 0:00 hr:min*
- * starting 10 min after the dive
- 0 to 99° F (-9 to 60° C)
if outside of temp range, then displays - -
- 0:00 to 23:59 hr:min
- 9:59 to 0:00 min:sec
- 23:50 to 0:00 hr:min

Resolution:

- 1
- 1 FT (.1/1 M)
- 1 %
- 0.01 ATA
- 1 minute
- 1 minute
- 1 minute
- 1 minute
- 1 minute
- 1 minute
- 1 second
- 1 minute
- 1 second
- 1 minute
- 1 minute
- 1°
- 1 minute
- 1 second
- 1 minute

Max Functional Depth:

- DIVE/FREE/GAUGE
- Watch Housing

Limit:

- 330 FT (100 M)
- 400 FT (120 M)

FCC ID: MH8A

FCC COMPLIANCE:

This equipment complies with Part 15 of the FCC Rules. Operation is subject to the following two conditions: 1.) this equipment may not cause harmful interference, and 2.) this equipment must accept any interference received, including interference that may cause undesired operation.

FCC INTERFERENCE STATEMENT:

This equipment has been tested and found to comply with the limits for an Intentional Radiator, a Class B Digital Device, pursuant to Part 15 of FCC Rules, Title 47 of the Code of Federal Regulations. These rules are designed to provide reasonable protection against harmful interference in a commercial or residential installation. This equipment generates, uses and can radiate radio frequency energy and, if not installed and used in accordance with the instructions, may cause harmful interference to radio communications.

There is no guarantee that interference will not occur in a particular installation. If this equipment does cause interference to radio or television reception, which can be determined by turning the equipment off and on, the user is encouraged to try to correct the interference by one or more of the following measures:

- Reorient or relocate the receiving antenna.
- Increase the separation between the equipment and receiver.
- Connect the equipment to an outlet on a circuit different from that to which the receiver is connected.
- Consult the dealer or an experienced radio/TV technician.

⚠ CAUTION: Changes or modification to this unit not expressly approved by Aqua Lung International could void the user's authority to operate the equipment.

ABBREVIATIONS/TERMS

ACT = Activation	MOD = Maximum Operating Depth
AL = Alarm	N2 = Nitrogen
ALT = Alternate	N2 Bar Graph = Tissue Loading Bar Graph
ASC Bar Graph = Ascent Rate	NDL = No Decompression Limit
ATA = Standard Atmosphere (unit)	NO DECO = No Decompression DTR
AUD = Audible Alarm	O2 = Oxygen
BATT = Battery	O2 MIN = Oxygen Time Remaining (DTR)
CDT = Countdown Timer	O2 SAT = Oxygen Saturation
CF = Conservative	PC = Personal Computer (download)
CLR = Clear	PLAN = Dive Planner
DA/dA = Depth Alarm (Free Dive)	PO2 = Partial Pressure of O2 (ATA)
DCS = Decompression Sickness	RDI = Repeating Depth Interval
DECO = Decompression	RTI = Repeating Time Interval
DFLT = Default	SAFE = Safety (stop)
DS = Deep Stop	SAT = Desaturation Time
DSI = Dive Surface Interval	SEA = Sea Level
DTR = Dive Time Remaining	SEC = Seconds (time)
DURA = Duration (backlight)	SLO = Slow Down
EDT = Elapsed Dive Time	SN = Serial Number
EL = Elevation (altitude)	SR = Sample Rate
FLY = Time To Fly	SRT = Surface Recovery Time
FO2 = Fraction of Oxygen (%)	SS = Safety Stop
FORM = Format (date, time)	SURF = Surface
FREE = Free Dive Mode	TOT = Total
FT = Feet (depth)	TTS = Time To Surface
GAU/GAUG/GAUGE = Digital Gauge Dive Mode	VIO/VIOL = Violation
GTR = Gas Time Remaining	
H2O = Water	
HIST = History	
IMP = Imperial (measure)	
LAST = Previous (dive)	
LO = Low (battery)	
M = Meters (depth)	
MET = Metric	
MFD = Maximum Functional Depth (equipment limits)	
MIN = Minutes (time)	

AQUA  LUNG®

www.aqualung.com